



NEXT LEVEL GUITAR[®]
LEARN FROM THE LICK SERIES – ROCK LICKS
WRITTEN LESSON MANUAL
-written by David Taub

INTRODUCTION:

Hello good people! David Taub here and I want to take a second to thank you for purchasing this Next Level Guitar instructional product. I think you will find that my teaching methods are of the best available on the market today. I have successfully taught thousands of students both privately and online all over the world and I am dedicated to getting your playing to the next level in the fastest and most efficient manner. This written lesson booklet was designed to coincide with the Learn from the Lick Series – Rock Licks course.

This Rock Licks course comes complete with three DVDs, and an audio CD with ten full on audio jam tracks. Each jam track includes a full band playing minus the lead guitar. The DVDs, audio CD, and this book of written lessons is an excellent tool for the guitarist to develop and enhance their lead guitar playing, improvisation skills, music theory knowledge, scale and mode learning, rhythm, and timing.

Use these instructional materials to help open up lead guitar avenues and to examine different lead guitar licks, lick techniques, scales, and modal playing. I designed the lessons and jam tracks to give you the most complete and limitless lead guitar picture possible.

If you don't keep a practice log you want to start one for sure. A three ring binder with filler paper works best. Print out this booklet of written lessons and keep it with all other music reference materials in the three ring binder. Keep these items handy so you can refer to them when studying and practicing.

Add filler paper to your binder and keep accurate records in your practice log of the items you are working on, what needs work, chord changes, progressions, songs, original material, scales, etc. Date the entries and keep track of your progress as you move forward in your guitar journey. Just like settings goals in life you want to set musical goals.....and then go out there and achieve them.

Remember to follow my structured curriculum, keep on practicing the right things, and keep developing your ear. Don't overwhelm yourself by trying to take on too many new things at once. Take these lessons and techniques in stages. Slow and steady wins the race. Some of the more advanced licks and faster runs will take time to digest. Stay positive and remember that your guitar playing is an evolution.

Like with anything new and different on the instrument dive into these materials with an open mind. Know that if you practice these techniques, work hard, keep honing your skills and refining your art that these methods will bring you results.....guaranteed.

Enjoy these materials and please let us know if you have any questions. We also always welcome your insights and feedback as we are constantly tweaking our products to make them the best they can be. Feel free to email us at thenextlevelguitar@yahoo.com

And please check out our full on video instructional website at www.nextlevelguitar.com

.....now let's get to it!

I wish you the best in all your musical endeavors.
Thanks again, enjoy the journey, and as always.....ROCK ON!
David Taub
www.nextlevelguitar.com

TABLE OF CONTENTS:

<u>Written Lesson</u>	<u>Page</u>
Introduction.....	2
Table of contents and Rock Jam Track CD listings.....	3
Getting started.....	4
The choices when soloing.....	5
Key points to determine soloing avenues.....	6
The jam tracks one by one - lead playing application over each jam track.....	7-11
Top ten key hints to get your playing to the next level.....	12-13
Notes on the fretboard.....	14
Finger Exercises.....	15
Chord construction.....	16-17
Building chords from the Major scale.....	18
Scales defined & drawn out.....	19
Lead Playing – rhythm, the ride, note choice, & phrasing.....	20
Solo theory for minor key.....	21-23
The Minor Pentatonic scale.....	24
The Minor Pentatonic expanded I scale.....	25
The Minor Pentatonic expanded II scale.....	26
The Minor Pentatonic scale – five box scales.....	27
The Minor Pentatonic Blues scale.....	28
The Minor Pentatonic Blues expanded II scale.....	29
The Minor Pentatonic Blues scale all five box scales.....	30
Spicing up the Minor Pentatonic Blues scale.....	31
The Major Pentatonic scale.....	32
Major Pentatonic Sus4 scale.....	33
Major Pentatonic Sus4 scale links.....	34
The Major scale.....	35-36
Major scale links.....	37
The Modes of the Major scale - overview.....	38-40
The Modes of the Major scale - individually.....	41
Applying the modes of the major scale.....	42
The Natural Minor Scale (Aeolian Mode).....	43
The Dorian Mode.....	44
The Harmonic Minor Scale.....	45
Harmonic Minor 3-octave scale link.....	46
Get started playing arpeggios.....	47
Playing arpeggios and modes over each chord.....	48
More arpeggio playing exercises over each chord.....	49
Sus4 and 7Sus4 long form arpeggios.....	50
Minor Pentatonic madness over chords.....	51
Major Pentatonic madness over chords.....	52
Circle of fifths.....	53
Order of sharps & flats.....	54
Blank tablature staff paper (document your favorite riffs).....	55-57

NEXT LEVEL GUITAR ROCK TRACKS AUDIO CD

Track 1 – E Heavy Rock	E5-F5-G5	122 BPM	4:18 min
Track 2 – D Power Cord Rock	D5-F5-G5	100 BPM	2:49 min
Track 3 – G Major Ballad	G-D-Em-C	74 BPM	4:15 min
Track 4 – E Rock	E-G-D-A	92 BPM	3:55 min
Track 5 – B Minor Blues	Bm-Em-F#m	98 BPM	3:30 min
Track 6 – C Half Step Rock	C5-C#5 F5-F#5	130 BPM	3:05 min
Track 7 – G Rock	G-A-C-D	98 BPM	3:46 min
Track 8 – A Minor Rock Out	Am-F-G	85 BPM	4:16 min
Track 9 – C Major Ballad	C-Em-Am-G	102 BPM	3:56 min
Track 10 – Bm Mellow Groove	Bm-F#	100 BPM	3:58 min

GETTING STARTED

Keep in mind that I want to give you the most complete guitar curriculum possible. This does not mean you have to master every lead guitar avenue listed in each jam track before moving on to the next jam. In fact you may not understand some avenues listed under each jam and that is okay. In these materials I teach many lead guitar avenues and some will take a bit to sink in and lots of practice to get really get comfortable. But over time you will get it and it will all make sense. Don't put any undue pressure on yourself and for sure don't overwhelm yourself.

At first take the lead guitar paths that you are comfortable with or what I list out at the top of each jam first, playing what relates to all. Then continue to study these lessons and try moving down the list of suggestions for each jam. As stated before some of the suggestions are more advanced and will take some time but remember there are no short cuts here. Don't rush things and don't skim over topics. It's important to learn about the "why" things work as I write out in the below written lessons throughout this book.

Learning the "why things work" will then give you the power to blast these avenues and techniques across all your lead playing. It will give you the lead guitar confidence to be able to instantly know what avenues are possible when soloing and improvising. That's the trick, to use these jams as "vehicles" to learn the needed why things work, and then develop them into your guitar arsenal. Then you have the tools to blast these lead playing techniques across all your playing at any given time, in any given jam, and in any given song.

Take things in stages and with patience. Know that your lead playing is an evolution and some of the concepts taught in these materials are more advanced and will take time and practice to get sounding fluid. Be patient with your playing and it will evolve over time. Your playing is an evolution.

When first starting each jam I suggest listening to the chords and then playing the rhythm progression a few times around so you can feel the amount of measures on each chord and get a good feel for the changes. Listening is an art, so really try and dial in your ear.

Don't forget that even though these are lead guitar materials, to further develop your lead guitar skills you want to keep practicing and working on your rhythm skills. Your rhythm and timing are critical elements to your overall abilities on the guitar. Never forget that your lead playing will really only ever be as good as your rhythm playing.

As I dive further and further into lead guitar techniques and concepts in this book, keep in mind that these very systematic and methodical techniques will seem a bit daunting at first. However, these will soon become second nature and automatic, they will become engrained in your playing style. You won't have to think about what to play so much as it will eventually become second nature. Then you will be letting your ear take you to all the right notes and chords and not having to think about techniques and application so much but rather focus on emotion and feel in your playing – the more you practice and apply these materials the faster you will be on "autopilot".

That said, throughout my teaching career I have found that first learning things systematically will get your lead playing to the next level the fastest. Remember we are building your lead guitar chops here and you need to have that solid foundation to build upon as you move along in your guitar journey. These methods work!

Even though you will often be utilizing Minor Pentatonic scales often over rock jams, I suggest trying some additional lead guitar avenues that I outline below. Many big name players and rock bands have no doubt made careers using pentatonic scales. However, I urge you to try some of the other suggestions that I list for each jam, as you don't want to limit yourself. You will also want to get comfortable with the Dorian and Aeolian modes. They often sound killer over rock jams. I teach the modes of the major scale in depth later in this book. You will soon discover modal playing will open up all kinds of new lead guitar avenues.

KEY POINT: Keep in mind that at this stage of your lead guitar playing journey there is just no substitute for practicing the right things, learning scales, studying the sounds and relationships between chords and scales, developing your ear, practicing and honing your skills using jam tracks, and continually pushing yourself and refining your art.

YOU CAN DO IT – STAY POSITIVE!

THE CHOICES WHEN SOLOING

Remember when you are soloing or improvising, you have **TWO CHOICES** – you can:

1. Play “**what relates to all**” – this means you solo with the same scale or same mode over **all the chords**. No matter what chord is being played in the progression you play the same scale or mode over each chord – you are playing what works over **ALL the chords and chord changes**. You play the same scale or the same mode no matter what chord is going by in the rhythm – you play **what relates to all** the chords.

This is probably the most common choice among guitarists and definitely what most players do when first learning or developing their soloing skills and chops. **So start with what relates to all**. You want to get good at this first before moving on to the next choice of playing over each chord independently.

OR YOU CAN:

2. “**Treat each chord like a separate event**” - this choice is much more challenging but will give you a more sophisticated sound. By treating each chord as a separate event you solo with a different scale, mode, or arpeggio **over each chord**. So you can change your scale, mode, and/or arpeggio with each chord change. You don't stay within the confines of the same scale as with what relates to all.

This technique gives you a more sophisticated sound and is much more challenging to apply than playing what relates to all. You have to listen to what is going on underneath your soloing. You have to listen to what chords are going by and you have to listen for the changes. You then have to time your playing and change your scales depending on what chord you are soloing over.

You want to employ this technique when you have enough time on a given chord. Obviously if the chords are flying by fast you won't have enough time to treat each one as a separate event. So remember to listen to the chords and the amount of time on each chord to determine if this technique can be utilized. This technique takes practice getting used to but it will skyrocket your playing to the next level. Practice this technique at first with slow tempo progressions where there is lots of time on each chord before they change to the next chord.

KEY POINT: Keep in mind **the above two choices are NOT mutually exclusive to one another**. You can mix them both. In fact I do that often when soloing. I treat each chord as a separate event for a while, then switch it up and play what relates to all or vice versa. It's a great combination to do both and you get some great effects from mixing them both together. Many big name players employ these techniques.

Sometimes you can even use both major and minor scale elements in certain jams as well as modal playing. In those type examples you can throw a bunch of different soloing applications into the soup. All depends on the chords you are playing over. And again, the technique is very common in the blues.

EXAMPLE PROGRESSION: JAM TRACK 5 – B minor Blues Bm-Em-F#m

To illustrate the above two choices let's use Jam #5 in which the changes are Bm-Em-F#m. This jam is in the key of B minor. We instantly know since we are in minor key, with no major V chord, we can solo with Minor Pentatonic & Blues scales over all the chords. We are in the key of B minor so we can play B minor Pentatonic & Blues over all the chords, those scales relate to all. So whether we are playing over the Bm chord, the Em chord, or the F#m chord we can play B minor Pentatonic & Blues scales all day long over all the chords.

We also know, (as I will teach in coming lessons), we can play a minor mode over all the chords. In minor key usually a minor mode relates to all. Since we are in minor key and when analyzing the chords the IV chord is minor, (Em), this tells us we can also play B Aeolian mode, (B Natural Minor), over all the chords. B Aeolian relates to all the chords in the progression and will work over all the chords. So again whether we are playing over the Bm chord, the Em chord, or the F#m chord we can play B Aeolian scales over all the chords– it relates to all.

We can also try choice number two and treat each chord as a separate event. What this means is you play what relates to each chord separately and treat each chord independently. Over the Bm chord you can play something that relates specifically to that Bm chord, like B Minor Pentatonic & Blues, B Aeolian, B Dorian, or B minor arpeggios. But then when the chords change to Em you then abandon all the B minor lead work and switch to scales, modes, or arpeggios that relate to the Em chord. Try E Minor Pentatonic & Blues, E Aeolian, E Dorian or E Minor arpeggios. Then when the chord changes again to F#m you abandon all the Em work and switch to what relates to the F#m chord. Try F# Minor Pentatonic & Blues, F# Aeolian, F# Dorian or F# minor arpeggios. Each chord change gets treated as a separate and independent event and you time to change your lead playing as the chords change. It's an awesome technique that will really take your playing to a whole new level.

Key Points To Determine Soloing Avenues, (explained in depth in coming lessons):

1. **Determine the key signature** - most of the time you will be soloing in minor key or major key. Knowing the key is the first step. Even when you are just noodling around on the guitar, always know what key you are playing in.
2. **Analyze the chord progression** – it's the chords that will give you the complete roadmap to what you can utilize for soloing and improvisation. Analyzing the chords is critical to get the full lead guitar picture. Knowing what key you are in is only part of it, **analyzing the chords gives you the full lead guitar picture.**

To get your playing to the next level along with fully exploring the pentatonics, you will want to explore playing in the modes. Later in these materials we will discuss the modes of the Major Scale. These modes are all those Greek names you have probably heard of like Aeolian, Dorian, Phrygian, Lydian, Mixolydian, etc. Don't let modal playing intimidate you at all. Just think of the modes as just being variations of the major scale. All you will be doing is starting and emphasizing a note in the major scale other than the root note, (much more to come on that).

Remember the points I list throughout these materials are guidelines to get you started off. They are not necessarily rules forged in stone. Often in jams you have to use your discretion. You want to learn the rules so then you can go ahead and break them. Creativity is key and listening and learning how certain notes, scales, or arpeggios work over certain chords or progressions will get you to your guitar goals. Learn the rules, use your ear, practice trial and error, find what sounds best to your ears, and keep honing your skills and refining your art.

MINOR KEY:

-In most instances if a song or jam is in minor key or it's a major key I-IV-V blues, swing, or shuffle you can solo using Minor Pentatonic & Blues over all the chords. So that should be a default setting. As soon as you determine you are in minor key, or it's a major key bluesy I-IV-V, you know one option is to solo over all the chords with Minor Pentatonic & Blues scales. (An exception to this rule is if there is a major V chord, then one option is to use Harmonic Minor over that chord, as I will explain in the Harmonic Minor Scale lessons on pages 45-46).

-Usually a minor mode will work over all the chords in a minor key jam. Usually it's either Aeolian or Dorian. To determine which one you have to analyze the chords and look for certain things. I will explain this in depth in the coming lessons but for now just memorize this critical point for soloing in minor key **over all the chords**:

KEY POINT: When playing over all the chords in a minor key progression you can always use the **AEOLIAN** mode, **UNLESS** there is a **IV** major chord or **II** minor chord, then use the **DORIAN** mode. (Exception - If there is a **V** major chord then use Harmonic Minor over just that **V** chord)

When to use Minor Pentatonic & Blues Scales (4 great applications):

1. **Over all the chords** in a minor key song, jam, or progression, (in most instances, few exceptions).
2. **Over all the chords** in major key I-IV-V blues, shuffles, and swings.
3. **Over any minor type chord** when treating each chord as a separate event.
4. **Over all the chords** in rock type jams, or jams using power or 5th chords, (as long as the jam is not real ballad/major sounding, if so then use major pentatonic or possibly full major scales).

Just to clear up some possible confusion - Aeolian mode is the same thing as Natural Minor or Pure Minor. They are all the same scales just with different names. **Aeolian mode = Natural Minor = Pure Minor**

MAJOR KEY:

-If a song or jam is in major key you can always solo using Major Pentatonic over all the chords. So that should be another default setting. As soon as you hear major key, you know one option is to solo over all the chords with Major Pentatonic, just like how you can use minor pentatonic over all the chords in minor key.

-MAJOR KEY I-IV-V blues, shuffles, or swings

-If a song or jam is a major key I-IV-V blues, swing, or shuffle there are **MANY** avenues to utilize when soloing and improvising. It's wide open and these I-IV-V progressions are extremely common in the blues.

-Try Minor Pentatonic & Blues scales for that darker, bluesy minor sound.

-Try Major Pentatonic for that sweet major sound ala BB King/Allman Brothers. This will be a totally different sound than Minor Pentatonic.

-Try mixing both Minor Pentatonic & Blues and Major Pentatonic. You will hear this a lot in the lead playing of Eric Clapton and BB King. The switching, combining, and mixing Minor and Major Pentatonics is an awesome sound!

-Try the Dorian mode. Dorian is considered more of a minor mode as it's intervals have elements of both minor, (b3, b7), and major (2nd, 6th). So Dorian works great in any situation where you know both Minor and Major Pentatonic will work.

-Mixolydian mode works great over dominant chords like 7ths and 9th chords, (often used in the blues).

THE TRACKS ONE BY ONE - LEAD PLAYING APPLICATION OVER EACH JAM TRACK ON THE CD

Below is an outline of each track on the Jam CD followed by a breakdown of the chords, progressions, key signature, and Beats Per Minute (BPM). Following each track is a list of suggestions on what you can try improvisation wise over the chords and progressions. Work on what you know first and move into the newer more advanced techniques with patience over time. Don't overwhelm yourself. Remember there are usually many lead avenues to choose from, so why not explore them all and get creative and see what sounds best to your ears.

Some of the jams are wide open so many different lead guitar avenues can be explored. Some are not as open. Explore the written lessons further to learn why these avenues work and continue to explore new lead guitar avenues and pathways. Get creative and challenge yourself to try new things and eventually come up with other lead guitar avenues that work within your personal playing style.

TRACK 1 – E Heavy Rock E5-F5-G5 122 BPM Key of E 4:18 min

By analyzing the chords we determine this is rock jam using 5th or power chords. 5th chords contain just two notes, a root and the 5th. There is no 3rds in power 5th chords so nothing to clash against the flat 3rd in minor pentatonic scales. That is why minor pentatonic sounds so awesome in rock jams. Because there are few notes in the chords this jam is wide open for a few different solo avenues to try. We are in the key of E and the chords in this jam are a I–b2–b3 or E–F–G and it is not real major sounding or a ballad jam so minor pentatonic works.

There is a b2 chord in this progression. As soon as you see a flat 2, (b2), chord in a jam you want to examine Phrygian mode as a possibility.

KEY POINT: Whenever you see a b2 chord in a progression you want to examine Phrygian mode as a possibility for soloing.

***What Relates to all the chords:** Fairly wide open jam to try a few things over all the chords.

-Try **E Minor Pentatonic & Blues** over all the chords – minor pentatonic sounds awesome over rock jams. (Be sure to try and spice up that scale with all the extras as I teach in the lesson on spicing things up on page 29.

-Try **E Phrygian** over all the chords. Phrygian would be the mode that would apply to all the chords in this jam. Phrygian is the 3rd mode of the major scale and E Phrygian is the same as C major. So play all your C major scales but start on and emphasize the E notes making it E Phrygian, (Learn the modes on pages 36-40).

Phrygian mode is the same as Aeolian mode but it has a b2. If we examine all the notes in the chords of we have an E5, (E and B notes), an F5 (F and C notes), and a G5 (G and D notes). E Phrygian scale is E,F,G,A,B,C,D. It's the same a C major, no sharps or flats – look how that will work over the chords in this jam – no rubs at all. Try it over all the chords as E Phrygian relates to all and sounds killer over all the chords. (E Phrygian=C Major)

-**E Aeolian** can be played over all the chords but you have to be careful as in the scale there is an F# note and that will rub if you hit that note over the F5 chord. So E Phrygian is a better choice over all the chords. Remember the only difference between Phrygian and Aeolian is Phrygian has a flat 2nd while Aeolian has a natural 2nd. Now the F5 chord is going by fast so it will be minimal so that is why I list it E Aeolian as a possible here. That and most players are more familiar with Aeolian or natural minor than Phrygian. E Aeolian is the same as G major – so play G major scales starting and emphasizing the E notes and you have E Aeolian. G major = E Aeolian

-Try mixing both **E Phrygian** and **E Minor Pentatonic & Blues** over all the chords for some killer sounds.

***Treat each chord like a separate event:** In this jam the chords are moving very fast so there is not much time to solo independently over each chord. You are probably going to solo more with what relates to all as explained above. The F5 chord is way fast so very little time is spent on that chord. There is a little more time on the E5 and G5 chords to try a few different things independently over those chords.

-Try E Aeolian (=G major), or E Dorian (=D major), over the E5 chord or some E arpeggios over the E5 chord. The minor arpeggios work best here and sound dark and cool like Em, Em7, or Em9 arpeggios over the E5 chord.

-There is enough time to blast a G major arpeggio or G major lick over the G5 chord – give that a try.

TRACK 2 – D Power Cord Rock D5-F5-G5 100 BPM Key of D 2:49 min

Similar to track one above this is another rock jam using power 5th chords. We are in the key of D, and the chords in this jam are a I–b3–IV or D–F–G. So again we have a fairly wide-open jam with a few avenues to try. In this jam there still is not that much time on each chord so again you will probably be playing more of what relates to all than soloing over the chords independently.

***What Relates to all the chords:**

-Try **D Minor Pentatonic & Blues** over all the chords. Minor pentatonic sounds awesome over rock jams. This is not a real major sounding or a ballad jam so Minor Pentatonic & Blues works well.

-Try **D Dorian** over all the chords. Dorian would be the mode that applies to all chords here and Dorian is the 2nd mode of the major scale. D Dorian is the same as C Major. So play all your C major scales but start and emphasize the D notes and you have D Dorian. The tip off to why use Dorian here is that we have a IV major chord in the progression. And when soloing over all the chords in these minor modes like Dorian or Aeolian when there is a IV major chord in the progression or a II minor chord you want to use Dorian instead of Aeolian, (this is explained in detail below in solo theory on page 19-21).

-Try mixing both **D Dorian** and **D Minor Pentatonic & Blues** over all the chords for some killer sounds.

***Treat each chord like a separate event:** In this jam you don't have much time on each chord. So there is not much time to solo independently over each chord. You are probably going to solo more with what relates to all as explained above. You have the most time on the D5 and G5 chords.

-Try D Aeolian (=F major), or D Dorian (=C major), over the D5 chord or some Dm arpeggios over the D5 chord. Minor arpeggios will sound dark and cool like Dm, Dm7, or Dm9 arpeggios over the D5 chord.

-Blast a G major arpeggio or G major lick over the G5 chord – give that a try.

TRACK 3 – G Major Ballad G-D-Em-C 74 BPM Key of G 4:15 min

In this jam we have a very major sounding ballad in the key of G major. Since it is so ballad major sounding we know that minor pentatonic and blues will NOT work over all the chords. We have to seek out other soloing options that gel with the major feel of the jam. However, we can use Minor Pentatonic & Blues over the minor chord, Em, individually – so just don't throw Minor Pent out the window for this jam as yet.

***What Relates to all the chords:**

-Try **G Major Pentatonic** over all the chords. For any major key jam you can use Major Pentatonic over all the chords. Major Pentatonic relates to all in this jam. G Major Pentatonic is the same as E Minor Pentatonic. G Major and E Minor are relative major and minor. If you think more in terms of Minor Pentatonic or just know those shapes then play all your E Minor Pentatonic scales, but start on and emphasize the G notes and it will be G Major Pentatonic and have that real major happy sweet sound as opposed to the darker, bluesy minor sound.

-Try **G Major Scales** - full major scales in a ballad jam usually works. At first emphasize and resolve to the G notes then for a bolder solo statement try landing on the chord tones of each individual chord when the chords change. Major is also called Ionian mode and the relative Minor of G major is E minor. So if you know your Natural Minor scales play all your E Minor scales over all the chords but emphasize the G notes to make it sound Major.

***Treat each chord like a separate event:** In this jam the chords are moving slower than the previous two jams and you have a full slower measure on each chord. So this lends more to treating each chord as a separate event and soloing over each chord independently. Try mixing it up with these:

-Over the G chord play G Major Pentatonic, G Major scales, G Major arpeggios

(Note: some like the sound of the Lydian mode over major chords but I prefer using the Lydian mode over major7 chords. In this jam G Lydian over the G major chord the sharp 4 (#4) of the Lydian mode sticks out and you need to check that one out for yourself to see if you feel it's a pleasing note to your ear). (G Lydian=D major).

-Over the D chord play D Major Pentatonic, D Major scales, D Major arpeggios

-Over the Em chord play E Minor Pentatonic, E Aeolian, E Dorian, E Minor arpeggios

-Over the C chord play C Major Pentatonic, C Major scales, C Major arpeggios

TRACK 4 – E Rock E-G5-D5-A5 92 BPM Key of E 3:55 min

Here is a fun rock jam in the key of E using power 5th chords. Power 5th chords really lend to the rock Minor Pentatonic sounds. The chords in this jam are a I-b3-b7-IV or E-G-D-A

***What Relates to all the chords:**

-Try **E Minor Pentatonic & Blues** over all the chords – Minor Pentatonic sounds awesome over rock jams. Since this is not real major sounding or a ballad and no major V chord, Minor Pentatonic & Blues scales work very well.

-Try **E Dorian** over all the chords. Dorian would be the mode that would apply to all the chords in this jam as all the notes in all the chords are in the E Dorian mode (E,F#,G,A,B,C#,D). Dorian is the 2nd mode of the major scale and E Dorian is the same as D major. So play all your D major scales but start on and emphasize the E notes making it E Dorian. The tip off to why use Dorian over all the chords in this jam for that minor sound is that we have a IV major chord (A) in the progression and you don't want to play a C note over the A chord as it will rub – you want to play a C# - and that is in the E Dorian mode as opposed to E Aeolian which has the C note.

-Try mixing both **E Dorian** and **E Minor Pentatonic & Blues** over all the chords for some killer sounds.

***Treat each chord like a separate event:** In this jam the chords are moving pretty quick as you only have a half measure on each chord. So there is not much time to solo independently over each chord. You are probably going to solo more with what relates to all as explained above.

You can try and pop a few things in independently over each chord but don't get caught playing the wrong scale or arpeggio over the wrong chord or you have just blown all that hard lead work you just accomplished. This is why you need to determine the amount of time on each chord. As you move forward in your playing and are aware of this it will become a more "feel" type technique and more automatic than sit down and analyze.

TRACK 5 – B Minor Blues Bm-Em-F#m 98 BPM Key of B minor 3:30 min

Here we have a cool bluesy jam. It's a minor key I-IV-V 12-bar blues. With 12-bar progressions you have a lot of time on each chord. This is perfect for treating each chord as a separate event. This jam is in the key of B minor using all minor chords, Bm-Em-F#m, and an F#7#9 chord used in the turnaround. Treat the 7#9 chord like a minor chord if soloing over just that chord.

***What Relates to all the chords:**

-Try **B Minor Pentatonic & Blues** over all the chords. We instantly know since we are in minor key, with no major V chord, we can solo with Minor Pentatonic & Blues scales over all the chords – those scales relates to all. So whether we are playing over the Bm chord, the Em chord, or the F#m chord we can play B minor Pentatonic & Blues scales all day long over all the chords in this jam.

-Try **B Aeolian** over all the chords. We can play a minor mode over all the chords. In minor key a minor mode relates to all. Since we are in minor key and when analyzing the chords the IV chord is minor, (Em), this tells us we can also play B Aeolian mode, (B Natural Minor), over all the chords. B Aeolian relates to all the chords in the progression and will work over all the chords. B minor is the relative minor of D major. So play all your D major scales but start on and emphasize the B notes making it B Aeolian (B Aeolian = D major)

-Try mixing both **B Aeolian** and **B Minor Pentatonic & Blues** over all the chords for some killer sounds.

***Treat each chord like a separate event:**

-Over the Bm chord try B Minor Pentatonic & Blues, B Aeolian, B Dorian, or B minor arpeggios.

-Over the Em chord try E Minor Pentatonic & Blues, E Aeolian, E Dorian or E Minor arpeggios.

-Over the F#m chord try F# Minor Pentatonic & Blues, F# Aeolian, F# Dorian or F# minor arpeggios.

Track 6 – C Half Step Rock C5-C#5 F5-F#5 Key of C 130 BPM 3:05 min

This is an interesting rock jam where the power 5th chords move up a half step from C to C# and F to F#. You have a measure and a half on the C and F chords and only have a measure on the C# and F# chords. When analyzing the chords we see half steps. The C to C# and F to F# are a I to a b2 so that b2 always points us to check if Phrygian will work. Listening to the progression it has that rock vibe and with the 5th chords we know Minor Pentatonic & Blues will probably work well.

***What Relates to all the chords:**

-Try **C Minor Pentatonic & Blues** over all the chords. It's a rock track that is not ballad or major sounding and uses power 5th chords so it tips us off that Minor Pent will be one avenue. Just be wary that over the F# chord there can be a slight rub – but that chord comes and goes very fast so you have some leeway.

***Treat each chord like a separate event:**

-Over the C5/C#5 play **C Minor Pentatonic & Blues** and **C Phrygian**. C Phrygian is a perfect modal avenue as the chords change from C to C# or I to a b2. That b2 tells us to check out Phrygian and it works great over the C5 and C#5 chords. C Phrygian=G# Major, play all your G# major scales but start on and emphasize the C notes.

-Over the F5/F#5 play **F Minor Pentatonic & Blues** and **F Phrygian**. If we look at just the F to F# change as a separate event then just like in the previous change we see a I chord going to a b2. So Phrygian would be the mode to try. F Phrygian=C#major, play all your C# major scales but start on and emphasize the F notes.

-**Switch Pentatonics** and play C Minor Pentatonic & Blues over the C chords and then when the change happens switch to F Minor Pentatonic & Blues over the F chords.

-**Switch modally** and play C Phrygian over the C chords and when the change happens switch to F Phrygian over the F chords. This sounds amazing over this jam – give it a try!

TRACK 7 – G Rock G5-A5-C5-D5 98 BPM Key of G 3:46 min

Here is a rock jam using power 5th chords. Remember that Minor Pentatonic & Blues really lends to that rock vibe. So when you see power 5th chords one possible choice may be Minor Pentatonic & Blues. In this jam there is not a lot of time on each chord. The chords move by pretty fast with just a half measure per chord. So this jam lends more to playing what relates to all then treating each chord separately. Another interesting thing about this jam is that it sounds a little major sounding, it sounds happy. So we want to explore that and possibly try a few new things. This is where you need to use your ear and use your discretion.

***What Relates to all the chords:**

-Try **G Minor Pentatonic & Blues** over all the chords. Minor Pentatonic sounds awesome over rock jams with power and 5th chords.

-Try **G Dorian** over all the chords. Dorian would be the safest mode that would apply to all the chords in this jam. Dorian is the 2nd mode of the major scale and G Dorian is the same as F major. So play all your F major scales but start on and emphasize the G notes making it G Dorian. G Dorian = F Major

-Try mixing both **G Dorian** and **G Minor Pentatonic & Blues** over all the chords for some killer sounds.

-Try **G Major Pentatonic** over all the chords. Here is where the discretion comes in and you have to use your ear. The jam sounds a bit happy sounding and there are no major rubs with G Major pent so give it a try as it does work and sounds a bit sweeter than the bluesy Minor Pent – but both work – see what sounds best to your ears. Remember your relative majors and minors – G Major Pentatonic is the same as E Minor Pentatonic. So if you think of your Pentatonics as minors play all your E Minor Pentatonic scales but start on and emphasize the G notes which makes it G Major Pentatonic. (For a complete list of Majors and their Relative Minors check out the lesson on the Circle of Fifths on page 49).

-Try switching and mixing back and forth between G Minor Pentatonic and G Major Pentatonic

***Treat each chord like a separate event:** In this jam the chords are moving pretty quick as you only have a half measure on each chord. So there is not much time to solo independently over each chord. You are probably going to solo more with what relates to all as explained above. Try and pop a few arpeggios over each chord but you have to move quickly – give it a shot!

TRACK 8 – A Minor Rock Out Am-F-G 85 BPM Key of A minor 4:16min

Here is a minor key rock jam in the key of A minor. Remember in minor key to always look if there is a major IV chord or minor II chord. The chords are Am-F-G so actually there is no IV chord or II chord. The chords move relatively fast. You only have half a measure on the Am and F chords, and a full measure on the G chord. So you will probably be playing more what relates to all in this jam.

***What Relates to all the chords:**

-Try **A Minor Pentatonic & Blues** over all the chords. We instantly know since we are in minor key with no major V chord, we can solo with Minor Pentatonic & Blues scales over all the chords – those scales relate to all.

-Try **A Aeolian** over all the chords. We also know we can play a minor mode over all the chords. Since we are in minor key and when analyzing the chords there is no IV chord and no II chord to worry about that tells us we can also play A Aeolian mode, (or A Natural Minor), over all the chords. A Aeolian relates to all the chords in the progression and will work over all the chords. A Aeolian is the same as C major. Play C major scales but focus on and emphasize the A notes. A Aeolian = C Major

-Try mixing both **A Aeolian** and **A Minor Pentatonic & Blues** over all the chords for some killer sounds.

***Treat each chord like a separate event:**

-Since the Am and F chords move pretty fast there is not a lot of time to treat each as a separate event. However, the G chord is held for twice as long so try treating the G chord as a separate event and try using G major scale licks and G major arpeggios over just the G chord.

Track 9 – C Major Ballad C-Em-Am-G 102 BPM Key of C 3:56 min

In this jam we have a very major sounding ballad in the key of C major. Since it is so ballad type major sounding we know that Minor Pentatonic & Blues will NOT work over all the chords. We have to seek out other soloing options that gel with the major feel of the jam. However, we can use Minor Pentatonic & Blues over some of the minor chords individually, Em & Am, so just don't throw Minor Pent out the window for this jam as yet. By listening to the progression we have a full measure on each chord. So there is lots of time on each chord which is great for treating each chord as a separate event.

*What Relates to all the chords:

-Try **C Major Pentatonic** over all the chords. For any major key jam you can use Major Pentatonic over all the chords. Major Pentatonic relates to all in this jam. C Major Pentatonic is the same as A Minor Pentatonic. C Major and A Minor are relative major and minor. If you think more in terms of Minor Pentatonic or just know those shapes then play all your A Minor Pentatonic scales, but start on and emphasize the C notes and it will be C Major Pentatonic and have that real major happy sweet sound as opposed to the darker, bluesy minor sound.

-Try **C Major scales** - full major scales in ballad jams work well. At first emphasize and resolve to the C notes. Then for a bolder solo statement try landing on the chord tones of each individual chord when the chords change. Major is also called Ionian mode and the relative Minor of C Major is A minor. So if you know your Natural Minor scales play all your A Minor scales over all the chords but emphasize the C notes to make it sound major.

***Treat each chord like a separate event:** In this jam the chords are moving fairly slow and you have a full measure on each chord. So this lends to treating each chord as a separate event and soloing over each chord independently. Try mixing it up with these applications:

-Over the C chord play C Major Pentatonic, C Major scales, C Major arpeggios

(Note: some like the sound of the Lydian mode over major chords but I prefer using the Lydian mode over major7 chords. In this jam C Lydian over the C major chord the sharp 4 (#4) of the Lydian mode sticks out and you need to check that one out for yourself to see if you feel it's a pleasing note to your ear). (C Lydian = G major).

-Over the Em chord play E Minor Pentatonic & Blues, E Dorian, E Aeolian, E minor arpeggios

-Over the Am chord play A Minor Pentatonic & Blues, A Aeolian, A Dorian, A minor arpeggios

-Over the G chord play G Major Pentatonic, G Major scales, G major arpeggios

Track 10 – B minor Mellow Groove Bm-F# 100 BPM Key of Bm 3:58 min

This is a cool mellow groove in the key of B minor. The chords are moving fairly slow and you have two full measures on each chord. So this jam really lends well to treating each chord as a separate event. Even though there is an F# major chord in the progression, this jam has a real dark minor vibe to it. That tells me automatically that major sounding lead elements will probably not work well. Analyzing the chords we have a I minor chord, (Bm), going to a V major chord, (F#). Minor key jam with a V major chord is the exception to the Minor Pentatonic rule I spoke of earlier. This jam screams out Harmonic Minor over the V chord.

Exception rule

When you have a jam or song with a I minor chord going to a V major chord you have to be careful. Even though we are in minor key Minor Pentatonic & Blues would not sound great over that major V chord in these instances. That scale won't relate to that V major chord, just the Bm chord. So this jam is an example of the exception. Now if there was a lot more chords in the progression and that major V chord does not come up for a while then you may be able to play Minor Pentatonic over the other chords and hang on it for a while, until that major V comes up, then you have to switch or you will be playing some sour notes over that V major chord.

To illustrate further in this jam the V chord is F#. That chord is made of the notes F#, C#, Bb. In B Minor Pentatonic the notes are B, D, E, F#, A. The b7 is an A note. So if you play that scale over the F# chord and you hold on that A note over the F# chord there will be a rub as the F# chord has Bb note. Not so pleasing to the ear. Another not so great note is if you play that root note B or D over the F# chord as again the F# would rather hear resolution to the Bb note or C# note as both notes are in the F# chord.

***Treat each chord like a separate event:** For this jam treating each chord as a separate event is the way to go.

-Over the Bm chord try B Minor Pentatonic & Blues, B Aeolian, B Dorian, B Minor arpeggios

-Over the F# chord try **B Harmonic Minor** – Harmonic Minor sounds awesome over the V chord in a minor key jam. (Note – use B Harmonic Minor over the F# chord, not F# Harmonic Minor)

KEY POINT: Soon as you see a V major chord in a minor key jam then BMM – hit the V major with Harmonic Minor over that chord.

-Try B Aeolian over the Bm chord then switch to B Harmonic Minor over the F# chord and you will be wowed! There is only one note difference between the two scales so this may be the easiest avenue for you to try at first.

Remember that keynote in the Harmonic Minor Scale is the major 7th – it's located one half step behind the root. You get great tension and release playing that 7th and then going up a half step resolving to the root. Learn all about the Harmonic Minor scale on pages 41-42.

TOP TEN KEY HINTS TO GET YOUR PLAYING TO THE NEXT LEVEL

In my opinion there are certain principles that every guitar player should consider tackling to help evolve their playing to the next level. Some concepts and techniques are harder than others, and take quite a bit of work to get proficient. However, in the end you will be glad you took the extra time to learn the principles outlined below, as they will make you a better guitarist and a better musician. There are no real shortcuts here, it will be more work, and quite difficult at first, but in the end you will be a better musician if you take the time to nail these down. Go slowly at first and don't overwhelm yourself. These are processes that take time, remember that your playing is an evolution. Take stock in your playing and see if you are deficient in one or more of these areas and then really work hard on getting each up to speed. Keep honing your skills and refining your art and stay positive!

HINT 1: Use what you learn in these lessons as vehicles – not as isolated individual jams

Remember we are building and evolving your lead guitar playing skills so take these jam tracks and materials in as a musical education. The jam tracks are practical playing vehicles for you to practice and hone your lead guitar playing and improvisational skills. Take what you are learning from these materials and techniques and apply them to other jams, songs, and progressions. These jam tracks are not meant to be isolated guitar incidents. Rather they are examples to give you the musical tools so you can blast these techniques across ALL your playing. Use jam tracks as vehicles to move your playing to the next level.

HINT 2: JUST DON'T LEARN LICKS.....LEARN FROM THE LICKS

I have seen it over and over and over. Too many guitarists spend way too much time on just learning licks and stopping there. If you just learn a lick here and a lick there then in the end you know a few licks – what good is that really? You want to LEARN FROM THE LICK – what scale is that lick from, how is it used, over what changes can it be played, over what chords can it be played, how can I vary that lick to turn that one lick into twenty licks – that's what I mean – **LEARN FROM THE LICKS AND LEARN FROM THE JAMS IN THIS PACKAGE** - then you are arming yourself with the necessary tools to take your playing to the next level.

HINT 3: KNOW & ANALYZE THE CHORD PROGRESSION, knowing the key alone is not enough

I have seen this hold guitar players back time and time again. They focus solely on what key they are playing in and that is all they are tuned into. This can be very limiting as knowing just the key will only get you so far. Knowing what key you are playing in is important, but to fully develop your lead playing and improvisation skills you need to know more – you need to start examining the chords and progressions. Why limit yourself?

You want to know exactly what chords are in the progression and then analyze them to determine what scales, modes, and landing notes to utilize. In many instances you need to look at if there is a IV chord or V chord in a progression and are the chords major or minor. You need to know which notes make up the chords that you are playing over so you can use their respective chord tones as strong landing or emphasis notes. You will need to know the chords and their structure to fully understand and apply which mode you want to solo with.

KEY POINT: It's the chords that you are playing over that give you the full roadmap to what will work for soloing and improvisation purposes.

The key is only part of the equation – you want to start listening to and analyzing the chords underneath. At first, get in the habit of writing out the chord progression and thoroughly examining all the chords in the progression or song to get clear to all the soloing options. Consider this very methodical approach at first as training as it gets that solid musical muscle memory locked in. This way eventually your ear will be developed enough to take you to all the right notes – it just makes it easier and faster to get to that point following this structured plan. I have found that learning this methodical approach will get you there the fastest.

HINT 4: DEVELOP YOUR EAR

I always say, and will keep saying and repeating, one of the most important things that you can do as a musician is to **DEVELOP YOUR EAR**. This opens the door to amazing musical applications. Once your ear starts developing you will be able to hear strum patterns & rhythms and play them by ear without the worry of learning pattern ups and down strums. You will hear the color of chords and be able to discern major chords from minor chords from 7th chords and so on. You will be able to grab chords that give off a certain color or emotion that you may need for a given song when songwriting. You will be able to figure out and transcribe songs by ear. Your ear will also take you to those sweet sounding landing and emphasis notes and link the proper scale or mode to a given chord or set of chords. I can go on and on – develop that ear – its HUGE!

HINT 5: KNOW A LARGE CATALOGUE OF CHORDS

As a musician knowing a large vocabulary of chords is absolutely critical. Unless you want to be regulated to playing stock everyday A, D, and E all day long. Being able to play a lot of different chords proficiently and knowing how to embellish them is a difficult task, but so worthwhile. Knowing a large catalog of chords will open many doors and allow you to embellish and decorate your playing with all kinds of new musical melodies, rhythms, and endless song writing possibilities. Why play a stock, sterile, every day Aminor chord when you can play a much more interesting and harmonically rich Asus2, Am7, or Am9 chord. Embellishing chords is a great way to spark new ideas and infuse new life into old progressions and songs. Having chordal options makes it fun and exciting not only for the guitarist but also, and probably more importantly, for the listener.

HINT 6: KNOW HOW TO PLAY SOLID RHYTHM

Knowing a large catalog of chords is the first step. Next is being able to play solid rhythm. Music is more than just soloing, notes, and chords, it is also about rhythm and meter. As a guitarist you will be playing rhythm 85% of the time. So the misinformed players who thinks they can just concentrate solely on soloing and improvisation are in for a huge surprise first time they start playing with a band or jamming with other people. Your lead playing will pretty much only ever be as good as your rhythm playing. Your rhythm playing is huge so don't overlook it.

HINT 7: KNOW THE NOTES ON THE NECK

There is just no way around this one. Strive to learn the notes on the neck cold. You will always be a better musician and be able to speak the language of music if you take the extra time to learn the notes that make up each chord, scale, and the notes on the fretboard. This will also allow you to grab a needed note quickly at any time. Knowing the notes on the neck is a huge under taking, so make it a process to learn them over a period of time. Don't overwhelm yourself and try to get them all down in a week. Take things slow and learn one string at a time, then go to the next string. Utilize octaves to make the learning process a bit easier. Refer to the written lesson on page 18 illustrating the notes on the fretboard and the 12-note scale.

HINT 8: DON'T RELY SOLELY ON TABLATURE OR JUST LEARNING SHAPES

The problem with tablature and just learning scale shapes is that you don't learn the notes that make up the chords or the scales. Don't rely solely on tablature as then you are just learning finger position, fret numbers, and shapes. Try not to become too dependent on tablature. Tablature only tells you what fret number to play, it does not tell you the note that you are playing or the notes that make up the chords. Tablature is a fun way to learn songs if you don't read music so certainly use it and have fun with it, but don't fall into the trap of using it exclusively and not taking the time to develop your ear. Along with tablature learn the notes on the neck and what notes and what intervals make up each chord and keep developing your ear so you eventually wont need tabs.

HINT 9: JUST DON'T LEARN SCALES ALONE, ALSO LEARN HOW TO APPLY THEM

Too often players will learn dozens and dozens of scales, but they don't learn how to use them and when to apply them. Learning a scale by itself is not enough. Knowing when to utilize the scale and over which chords is just as important as knowing the scale itself. Knowing all the scales ever created in the history of music will do you absolutely no good unless you know how to utilize them and under which musical circumstances apply them into your playing. Learn the scale, but also learn how and when to apply it as I teach in these materials.

HINT 10: KNOW YOUR MAJOR SCALES COLD IN ADDITION TO THE PENTATONICS

This is invaluable for the lead guitar player. Knowing your major scales in all positions across the neck will help give you so many additional tools necessary for lead playing and improvisation. Too many players just stop learning scales after they learn the pentatonics. Again, why limit yourself? Knowing the major scales up and down the neck will be the springboard to knowing the modes of the major scale, relative major and minor, and many other important concepts. So learn those major scales in all positions. I have the major scales, major scales links, and pentatonic and blues scales, among many others, diagrammed out later on in this book. Don't stop after learning pentatonic scales, keep pushing into new territories and you will push yourself to that next level of lead guitar playing.

NOTES ON THE FRETBOARD

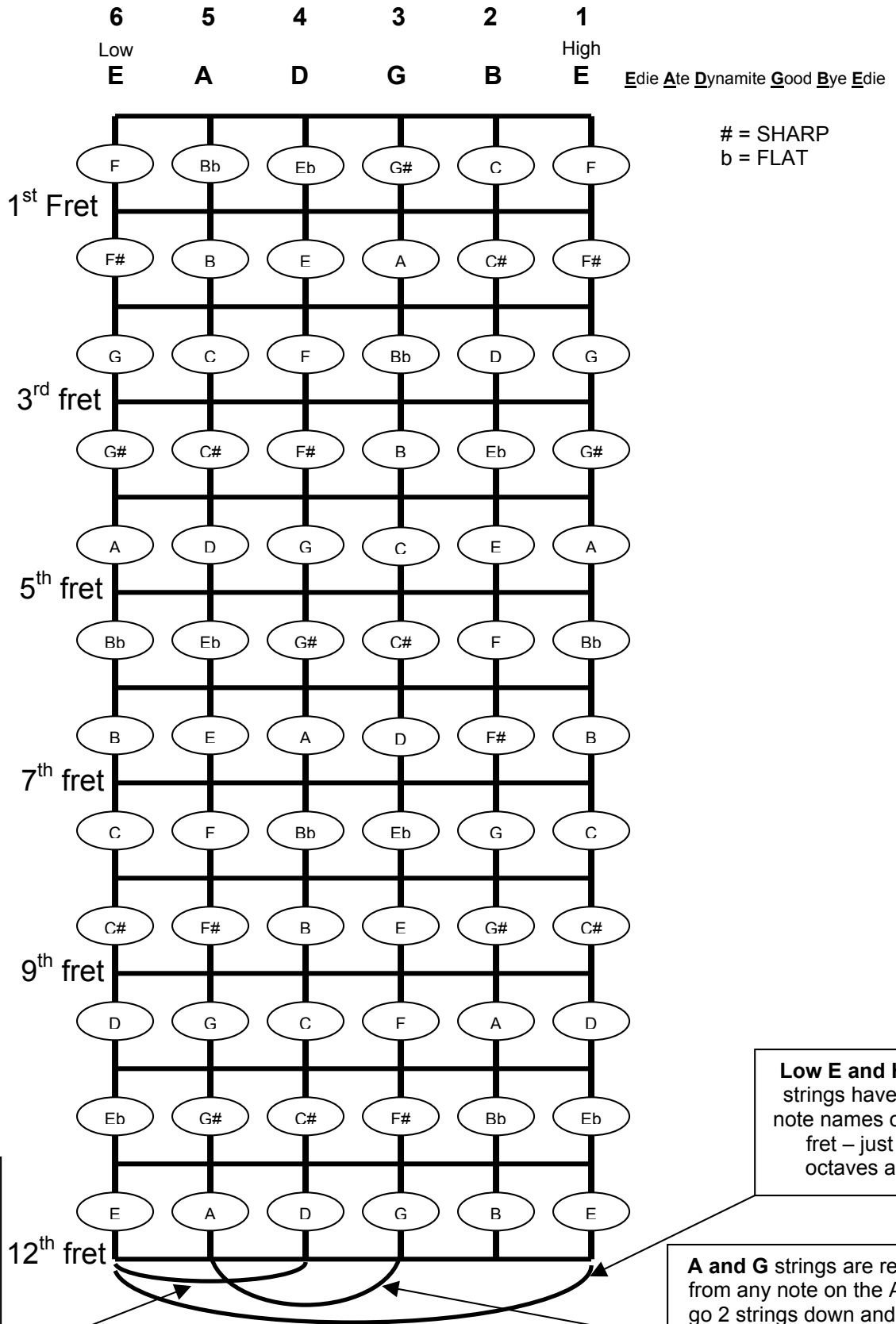

= SHARP
b = FLAT

E and D strings are related – from any note on the E string go 2 strings down and 2 frets over and you have the same note an octave higher on the D string

Low E and High E strings have same note names on each fret – just two octaves apart

A and G strings are related – from any note on the A string go 2 strings down and 2 frets over and you have the same note an octave higher on the G string

The twelve-note scale consists of:
A, B_b, B, C, C[#], D, E_b, E, F, F[#], G, G[#]

FINGER EXERCISES

Finger exercises are a very important element of a guitar players practice regimen. They can be utilized as warm up exercises when practicing or before live gigs. When finger exercises are done properly, and consistently integrated into your practice regimen, they build strength, dexterity, picking accuracy, finger mobility and speed, they tie the pick and fret hands together and help clean up your playing. They may seem boring, but they work, and work fast. Add these to your practice regimen every day and just by completing the exercises your playing with benefit immensely.

The various practice patterns are written out below and they will increase in difficulty with each new set. Remember, Rome was not built in a day, so it will take some time to master each one. Play each exercise slow, clean, with no overtones, dinks, sloppiness, or missed notes. Play them slow at first to get used to the patterns. Then slowly bring up the speed. When you are ready you can play to the click of a metronome to ensure that you are playing in time. Set the metronome at a comfortable speed. Then slowly bring up the speed of the metronome. I cannot emphasize enough to always play slow, clean, and in time rather than fast and sloppy. Go very slow at first.

Working these exercises ten minutes daily will increase your picking accuracy, speed, finger strength and overall finger dexterity. These can be completed while watching television, or waiting for something to download on your computer. Whenever you have a spare five minutes pick up the guitar and blast a few sets down the neck a few times.

The exercises below are written out in tablature. The numbers are the fret numbers that you will play. The finger pattern is the order of your fingers that you will be using during the entire exercise. Start each exercise on the low E string at the fret indicated and play every note on the fretboard with the given finger pattern. Keep your fingers as close to the fretboard as possible. Do not let your fret hand come way off the fretboard and out of position. Utilize strict alternate picking – up, down, up, down, etc. Remember to keep your thumb anchored on the back of the neck and not have it slide up and out of position. Continue with the finger pattern up the fretboard utilizing all six strings all the way until your first finger hits the 12th fret on the high E string and then go back and repeat the exercise 2-4 more times if possible. When you get to the end of a given exercise it is important to repeat it. To build strength the exercise must be played over and over again, multiple times. You will feel the burn the more you implement these exercises. If you feel pain, stop, shake your hand out, give it a rest, and confirm that you are utilizing the proper technique. Then start again after a little rest.

Exercise I – finger pattern 1,2,3,4

At this point shift up one fret and start with 1st finger on the 2nd fret on the high E string

At this point shift up one fret and start with 1st finger on the 3rd fret on the low E string

Exercise II – finger pattern 4,3,2,1

Practice each pair of patterns below every day for 2 weeks or until down cold before moving on to the next pair. Remember to do each one 2-4 times each up and back on the neck. Try to master one set before moving on the next set, but keep doing the previous sets as you move forward. Keep at it every day!

- Set 1 - 1,2,3,4 and 4,3,2,1
- Set 2 - 2,3,4,1 and 3,2,1,4
- Set 3 - 1,4,3,2 and 4,1,2,3
- Set 4 - 2,1,4,3 and 3,4,1,2
- Set 5 - 1,2,4,3 and 4,3,1,2
- Set 6 - 2,1,3,4 and 3,4,2,1
- Set 7 - 1,3,4,2 and 4,1,3,2
- Set 8 - 2,3,1,4 and 3,2,4,1
- Set 9 - 1,4,2,3 and 4,2,1,3
- Set 10 - 2,4,1,3 and 3,1,2,4
- Set 11 - 1,3,2,4 and 4,2,3,1
- Set 12 - 2,4,1,3 and 3,1,4,2

CHORD CONSTRUCTION

Understanding chord construction theory will give you the knowledge of why certain notes make up certain chords. Analyzing chord construction will also illustrate the relationships between notes, chords, and scales. It will tie many concepts together that we will discuss throughout these materials. Chord construction will help your lead playing as you will then know to land on the notes that make up the chords, or chord tones. You also will know what number each chord is referred to like what is the one chord (I), or four (IV) chord, etc., in a progression.

Chords are built from notes in certain scales. A scale is a series of sounds arranged by order of pitch, or alphabetically, from any given note to its octave. In order to analyze chord construction we need to look at scales and the notes that make them up. All major keys are constructed in the same fashion and all music theory is compared to the major scale. The major scale is the standard in music that all is compared. You have probably heard the major scale - doe, re, me, fa, so, la, ti, and then back to doe.

Lets examine the C major scale. The key of C major has no sharps or flats. In fact, C is the only major key with no accidentals, (a sharp or flat is also referred to as an accidental). So if you see a piece of sheet music and it has no sharp or flat symbols next to the clef you know it is probably in the key of C major.

C major scale = C, D, E, F, G, A, B,

The three notes that construct a major chord are a root or 1st degree, 3rd, and 5th, (1,3,5). So to illustrate the relationship between the key signature, chords, and notes lets draw out the C major scale and start counting. Remember that the scale is always laid out in order and each successive note is assigned a number or degree, and always in order. Start on the C and count to the third degree and you have an E note. In the key of C major the third is the E. Now count to the 5th degree or 5th note starting from the C note and you have a G note. In the key of C major the 5th is a G. Now put the three notes together as shown in the illustration below and you have a C major chord – root, 3rd, and fifth or C, E, G.

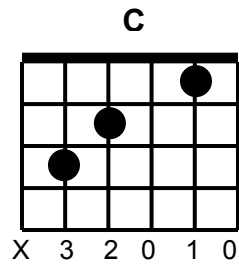
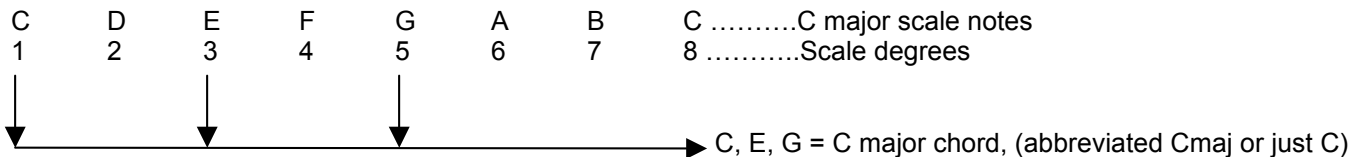

Lets look at an open C major chord illustrated on the left. Like all major chords it is constructed from the root, 3rd, and 5th degrees of the major scale. In the key of C major the notes would be C, E, and G as constructed from the C major scale illustrated above. Playing these notes on the guitar neck is a C major chord. So you can grab these three notes from anywhere on the guitar neck and play them together and you have a C major chord or some inversion of a C major chord. Now you can see from these three illustrations how the notes in a chord are constructed from a scale and their relationship degree chordal wise.

Expanding on this concept above lets build a C major 7th chord, (Cmaj7). Major 7th chords are constructed from the root, 3rd, 5th, and 7th, (1,3,5,7), degrees of the major scale. The major 7th chord is actually built off the major as it has the root, 3rd, and 5th degrees in it and then we add the 7th making it a major 7th chord. In the key of C major the root or 1st degree is a C, the 3rd is an E, and the 5th is a G. Let's draw out the C major scale again and begin counting degrees. The 7th degree in C major is a B. So put all the notes for a C major 7th chord together and we have the root, 3rd, 5th, and 7th and if we count degrees as illustrated below we have C, E, G, and B.

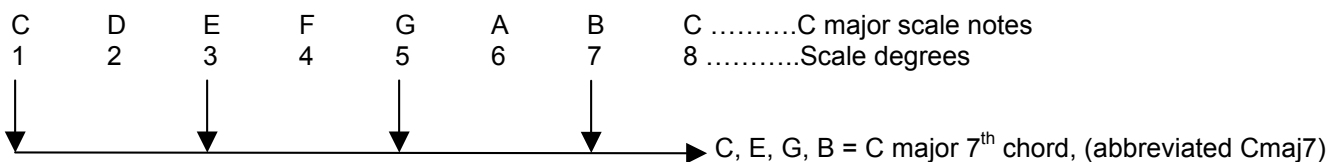

Cmaj7

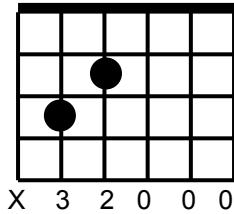

Lets look at an open Cmaj7 chord illustrated on the left. Like all major 7th chords it is constructed from the root, 3rd, 5th, and 7th degrees of the major scale. In the key of C major the notes would be C, E, G, and B as constructed from the C major scale as illustrated above. Playing these notes on the guitar neck is a C major 7th chord. So you can grab these four notes from anywhere on the guitar neck and play them together and you have a Cmaj7 chord or some inversion of a Cmaj7 chord.

Lets try this same principle but this time we are going to change keys to G major. Remember, as discussed in the lesson above, all major keys are constructed in the same fashion. The G major scale has one sharp or accidental, (F#). The key of G major is the only major key with one sharp. Here are the notes of the G major scale:

G major scale = G, A, B, C, D, E, F#

Let's draw out the G major scale and start counting. Starting on the root note G, count to the third degree and you have a B note. In the key of G major the third is the B. Now count to the 5th degree and you have a D note. In the key of G major the 5th is a D. Now put the three together as shown in the illustration below and you have a G major chord – root, 3rd, fifth or G, B, D.



G

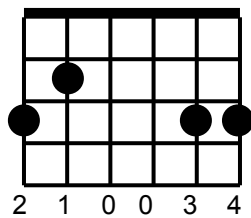

Lets look at an open G major guitar chord illustrated on the left. Like all major chords it is constructed from the root, 3rd, and 5th degrees of the major scale. In the key of G major the notes would be G, B, and D as constructed from the G major scale illustrated above. Playing these notes on the guitar neck is a G major chord. So you can grab these three notes from anywhere on the guitar neck and play them together and you have a G major chord or some inversion of a G major chord.

Expanding further with the G major scale let's build a G major 7th chord, (Gmaj7). Major 7th chords are constructed from the root, 3rd, 5th, and 7th degrees of the major scale as discussed above. In the key of G major the root or 1st degree is a G, the 3rd is a B, and the 5th is a D. Let's draw out the G major scale again and begin counting degrees. The 7th degree in G major is an F#. So put all the notes for a G major 7th chord together and we have the root, 3rd, 5th, and 7th and if we count degrees as illustrated below we have G, B, D, and F#.

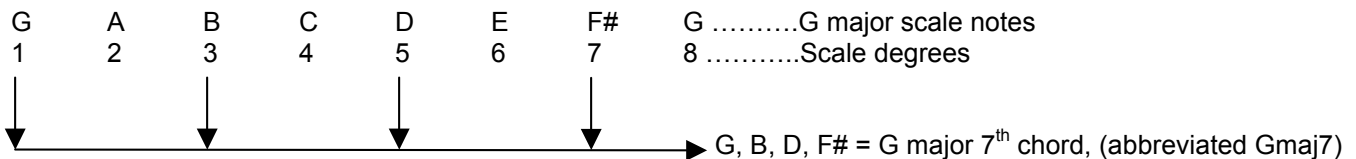

Gmaj7

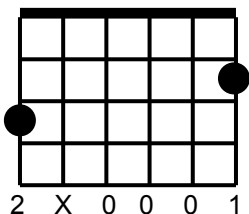

Lets look at an open Gmaj7 chord illustrated on the left. Like all major 7th chords it is constructed from the root, 3rd, 5th, and 7th degrees of the major scale. In the key of G major the notes would be G, B, D, and F# as constructed from the G major scale as illustrated above. Playing these notes on the guitar neck is a Gmaj7 chord or some inversion of a G major7 chord.

Building chords from the major scale – major key

As per the previous lesson we have learned that all music theory falls back to the major scale. The major scale is the standard in music that all is compared. Now we will build chords from each degree of the major scale and you will easily be able to know which chords are in any given major key. To find the notes in any major key, (major scale), start at the root and go up following this pattern: **whole step, whole step, half step, whole step, whole step, whole step, half step**. This will take you to the root one octave higher than where you began, and will include all seven notes in the major key in that octave. Remember, any chord *might* show up in any given key, however, certain chords are much more likely to be in a given key than others. The most likely chords to show up in a given key are the chords made from combinations of the notes in that keys' major scale. You'll find that although the chords change from one key to the next, the *pattern* of major and minor type chords is always the same for any major key. Lets examine the C major scale and build the chords in that key right from the scale. Follow this template to build the chords in any key.

If you start on C and skip every other note in the scale, also called stacking 3rds, for a total of 3, you have built a C major chord. The major chord follows the formula 1,3,5. So a C major chord is constructed from the three notes C, E, and G, the root of the scale, the third note of the scale, and the fifth note of the scale.

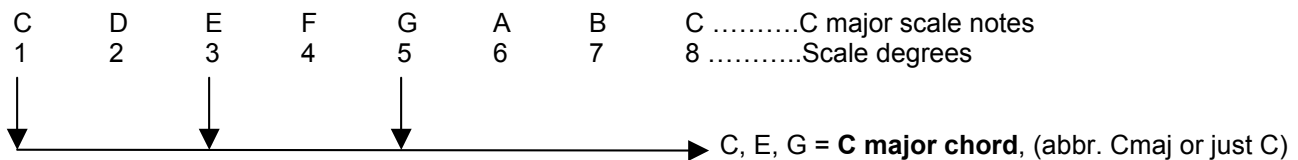

Now do the exact same thing stacking thirds except this time start on the D note. The D is the second degree or 2nd note, II, of the C major scale – so just keep stacking thirds, we then have the three notes that construct a D chord and if we examine those 3 notes, D,F,A, we see it's a D minor chord, (as illustrated below).

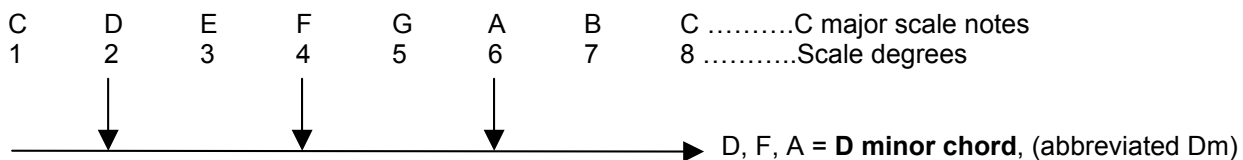

The process of stacking 3rd notes up in the major scale continues until you have a total of 7 chords, one for each note of the scale. Each note of the scale refers to a chord, 7 notes in the scale so 7 chords. Each major key will have a total of seven chords.

C D E F G A B C – E,G,B =Em (**E minor chord**)

C D E F G A B C – F,A,C =F (**F major chord**)

C D E F G A B C D – G,B,D =G (**G major chord**)

C D E F G A B C D E - A,C,E =Am (**A minor chord**)

C D E F G A B C D E F - B,D,F = B^o (**B diminished chord**)

Because major scales are always built from stacking thirds, the pattern is always the same for every major key. The chords built on the first, fourth, and fifth degrees of the scale are major type chords (I, IV, and V). The chords built on the second, third, and sixth degrees of the scale are minor type chords (ii, iii, and vi). The chord built on the seventh degree of the scale is a diminished chord.

KEY POINT: Whichever major key you are building chords from the pattern will always be the same. **Major....Minor....Minor....Major....Major....Minor....Diminished - commit this pattern to memory!**

SCALES DEFINED & DRAWN OUT

Understanding and learning scales is a critical element in your guitar journey. Scales are the roadmap to the fretboard and getting a good handle on them will allow you to eventually master the guitar neck.

Basically scales are a group or collection of notes in ascending or descending order that we use in music. Scales are listed out in order and usually from low to high.

The order of the notes used in a scale is crucial as that order provides a measure of musical distance. The distance between notes is called an interval. How scale notes line up, or the intervals, will give the scale not only its name but also its mood or musical flavor.

Just like certain chords have a mood to them, i.e major chords are happy and bright sounding, minor chords are dark sounding, major 7th chords are sweet and jazzy sounding, 7th chords are twangy and bluesy, scales also have a mood to them. Just like it's the notes in a given chord and their combination that gives the chord its mood or feel, it's the same with scales.

A critical aspect to a scale is its root note. The root note is the starting note and note which all the other scale notes gravitate toward. I like to call the root "home base". Most other notes seem to want to resolve to it and it's the tonic center for the scale. Many times I can know instantly the key of a given song or progression by just listening for what sounds like home base – what are all the chords or notes pulling towards. The root is very significant and we will be discussing it often throughout these materials.

So when learning scales always make mental notes as to where the root notes are in that scale. In every scale I diagram out in these materials I always note the root notes with black filled in ovals. It's critical to know your root note locations.

The successive notes in a scale are divided by steps, or tones. You will hear the word step a lot used in guitar lingo when relating it to the fretboard. Things like move it up a half step, or go up a minor third. This means:

Half step = 1 fret (also called a semi-tone)
Whole step = 2 frets (also called a whole-tone)

Minor Third = 3 frets
Major third = 4 frets

The below table illustrates some common scales and their intervals:

Major Scale	1, 2, 3, 4, 5, 6, 7
Natural Minor Scale	1, 2, b3, 4, 5, b6, b7
Minor Pentatonic Scale	1, b3, 4, 5, b7
Minor Pentatonic & Blues Scale	1, b3, 4, b5, 5, b7
Major Pentatonic Scale	1, 2, 3, 5, 6
Major Pentatonic Sus4 Scale	1, 2, 3, 4, 5, 6
Ionian Mode (Major Scale)	1, 2, 3, 4, 5, 6, 7
Dorian Mode	1, 2, b3, 4, 5, 6, b7
Phrygian Mode	1, b2, b3, 4, 5, b6, b7
Lydian Mode	1, 2, 3, #4, 5, 6, 7
Mixolydian Mode	1, 2, 3, 4, 5, 6, b7
Aeolian Mode (Natural Minor Scale)	1, 2, b3, 4, 5, b6, b7
Locrian Mode	1, b2, b3, 4, b5, b6, b7
Harmonic Minor Scale	1, 2, b3, 4, 5, b6, 7

Modes of the Major Scale

LEAD PLAYING - Rhythm, The Ride, Note Choice, & Phrasing

Lead playing is something that can identify a player like a signature or fingerprint. Players like Stevie Ray Vaughan, Jeff Beck, Eddie Van Halen, BB King, Eric Clapton, and Carlos Santana can be identified with a single note. They have a very signature sound and identifiable lead playing tone and technique that identifies them. As you continue your lead guitar studies and keep up with your practicing, you will find your playing will evolve over time. An element of lead playing which may seem simple, like vibrato, can take months and months to develop into a signature statement in your lead guitar bag of tricks.

GEAR/EQUIPMENT – Sometimes guitarists think that if they purchase the same guitar, amp, and effects of their favorite guitarist that they will cop their signature sound and replicate their tone. You will find that this is not the case. Here is a quick story to illustrate this point. When Van Halen was first starting out they opened for some name acts of the time. Eddie Van Halen was so revolutionary with his guitar playing that he virtually floored the guitar community. One show Van Halen was opening for Ted Nugent and Ted watched in amazement as Eddie played during sound check. Ted couldn't believe the sounds he was hearing. After Eddie left the stage Ted then talked Eddie's guitar tech into letting him plug into Eddie's rig. Ted Nugent starting playing through Eddie's gear and guess what - he sounded like Ted Nugent.

The point is that your tone comes mainly from your fingers and your technique, not the amp or effect. Tone is truly in your hands and in your heart. Gear can surely be motivating and empowering and point you in a certain direction, but ultimately your tone is in your hands.

Eddie Van Halen can play any guitar through any amp or effect and will still sound like Eddie Van Halen. You want to play through the best gear that you can afford, but spend time developing **your** technique and sound and not someone else's.

What you want to accomplish with your lead guitar playing and improvisation is two-fold:

1. Complement the song

2. Draw people in to your solo – you want the listener to latch onto what you are playing. You want to keep the listener on the edge of their seat wondering, "what is he going to play next"? Take the listener on a musical journey with ups and downs and great emotion and passion – play from the heart. Tell a story with your playing and always be aware of melody.

At times many guitarists forget the above two items and are off soloing in their own "little world". They forget about the song, the chord changes, and what the other musicians in their band are doing. What happens then is the song suffers, or the band has to "reel" the guitarist back into the groove. Below are four critical parts to great lead playing. Work on all four of these aspects by studying each individually, and then apply them.

1. Rhythm – the rhythm of your notes and licks. It's the way we take the notes we choose to play and do things with them. This quite possibly could be the most important element of lead guitar, taking the notes and doing musically interesting things with them. Repetition is one key component and melody is another.

Repetition is a key to good melody and phrasing. You don't have to play your licks verbatim every time in a lead line, but rather the same in concept. Noodle around on the guitar till you find a killer sounding riff – find the magic. Then dig into that idea that you like and keep repeating it. Repeat it but try playing it a little different rhythmically each time or maybe hit the same note two or three times one time, or do a bend one time, vary it. Learn to vary your magical licks. Learn a rhythm or rhythmic phrase and then apply it to some of your favorite licks across all the strings. So when you noodle around and get into a little cool idea – keep it – keep playing it – turn the rhythm around and exploit it. Remember rhythm and melody are key!

2. The Ride – I am talking about the ups and downs, the peaks and valleys, the highs and lows in your lead playing. It's the way your lines move up and down the neck and loud and soft dynamically. It is critical to have these peaks and valleys in your lead lines. You just don't want to be rambling on and on with straight across the board flat line playing. You want to move your listeners and draw them into your solo. Your solo should have ups and downs and twists and turns. You don't want only flat straight lines with no emphasis, connections, different rhythms, no dynamics, or sans any musical events or melody.

3. Note choice – this may seem pretty obvious but which notes you play and probably as equally important which notes you don't play. Note choice is what most players focus on but actually most players can benefit from building their rhythm and ride vocabularies and chops. For example, if you are playing the blues you have only have five or six main notes to choose from so note choices are limited – so you better have a very big rhythm and ride bag of tricks because that is what is going to make your lead lines sound interesting and not boring.

4. Phrasing – Basically a phrase is a group of notes that compose a musical thought. Phrasing is all about how you connect your notes, scales, ideas, and licks. You want to connect your groups of phrases in a manner that makes good musical sense. A manner which conveys a musical thought or musical passage. When you don't have a lot of note choices then you really have to concentrate on your phrasing to keep things interesting and different. Some players really excel at phrasing and it's very clear when someone is good at it. Listen to the playing of Stevie Ray Vaughan. The music just flows out of him. His playing is smooth and effortless with his musical thoughts and ideas phrasing effortlessly into one another. Almost like he had a direct channel between his brain, heart, and fingers. Work on your own personal channel and musical connections, its invaluable.

Solo theory for Minor key - using Pentatonic & Blues, Aeolian mode, Dorian mode and relative Major

When soloing and improvising it is absolutely critical to thoroughly examine and analyze the chords and chord changes in the song or progression. Many guitarists make the mistake of just looking solely at the key – that won't give you enough information.

The chords provide the road map for what scales, modes, and arpeggios you will want to utilize as well as point to the strong notes to land on and emphasize. Too many guitarists don't take the time to examine the chords and the chord changes, they just look at the key. Without examining the chords you won't have all the needed information to know what you can fully utilize for lead playing and improvisation.

We are first going to look at some very basic minor key examples, and be very structured about writing out the progression and the key points of application. There is a reason why certain notes and certain scales sound great over certain progressions and certain chord changes.

Over time your ear will develop to the point where you won't have to write out the structure, as we will do below. Your ear will eventually guide you to all the right notes and you will be doing it on the fly. But that takes time and practice to develop and get proficient. You have to work on it. One of the most important things to do as a guitarist is to **DEVELOP YOUR EAR**, this is one of the reasons why.

Before we move to other scales let's keep it basic and just look at when to utilize Minor Pentatonic, relative major scales, Aeolian mode, and the Dorian mode when soloing in minor key. Remember that Aeolian mode is the same thing as Natural Minor which is also called Pure minor, all three are the same thing. There are other scales and modes you can utilize, but for now let's just look at these.

Remember, as explained on page five, when you are soloing or improvising, you have two choices:

1. Play **"what relates to all"** – this means you solo with the same scale or same mode over **all the chords**. No matter what chord is being played in the progression you play the same scale or mode over each chord.

OR YOU CAN

2. **Treat each chord like a separate event** - By treating each chord as a separate event you solo with a different scale, mode, or arpeggio **over each chord**. So you can change your scale, mode, and/or arpeggio with each chord change. You don't stay within the confines of the same scale as with what relates to all.

For this lesson we will work on the first choice, using the same scale, mode, or arpeggios over all the changes. Playing what relates to all. Do this first to get good at analyzing the chords and playing a mode or modes over **all** the changes. Then we will move onto treating each chord like a separate event in coming lessons.

KEY POINT: Here is the big rule for when soloing over all the chords in a minor key progression or song:

When playing over all the chords in a minor key progression, you can pretty much always use the AEOLIAN mode, UNLESS the IV chord is major or the II chord is minor, then use the DORIAN mode. (Exception - If there is a V major chord then use Harmonic Minor over just that V chord)

This rule is absolutely critical and I strongly suggest that you burn it into your brain - you will be utilizing it all the time because so many jams, songs, and progressions are in minor key.

You want to add more weapons to your guitar arsenal in addition to Minor Pentatonic, so this rule is super important. When soloing in minor key, minor pentatonic and blues should be your default setting. In a minor key progression, (where the I chord is minor), you can pretty much always utilize Minor Pentatonic and Blues in that key, (unless there is a major V chord). That are pretty much a given.

As per above if there is not a change to a II or IV chord then Aeolian mode is implied and you can utilize the Aeolian mode over all the chords as well as the default setting of using Minor Pentatonic & Blues scales. So always think Aeolian unless you see a major IV or V chord or minor II chord.

But if you are soloing over all the chords in a minor key, and there is a major IV or minor II chord somewhere in that progression, whether that chord comes up 2nd, 4th, or 10th in the chord string, you don't want to play Aeolian mode over that chord because you will hit a very out of key note, the b6. So with a major IV chord or minor II chord in the progression you want to use Dorian mode over all the chords.

The reverse applies also - if you are soloing over all the chords and you have a IV minor chord come up 2nd or 5th or 10th in the progression, and you are mistakenly are using the Dorian mode over all chords, then you will hit a very out of key note over that IV minor chord, the major 6th.

There is only one note difference in the Dorian and Aeolian modes, that sixth. Aeolian has the b6 while Dorian has the major 6th. If you hit the wrong one over that chord it will sound extremely out of key. So its super important you play the right mode over all the chords. Minor pentatonic works regardless as there is no 6th in that scale, it's a root, b3rd, 4th, 5th, and b7th. Check out the examples below to illustrate this super important rule. Remember we are talking about when playing over all the chords in a progression, playing what relates to all.

EXAMPLE PROGRESSION 1: Dm to Gm progression

By analyzing the chords we determine we are in the key of D minor. The progression is a I minor chord, Dm, to a IV minor chord, Gm. Lay this change down with a slow groove and two measures per chord.

***What Relates to all the chords:**

-Try D minor Pentatonic & Blues scales over all the chords. Remember that's the default setting – since we are in the key of D minor, with no major V chord, we know that D minor Pentatonic & Blues will always work over all the chords all day long.

-Try D Aeolian mode over both chords as it also relates to all. Analyzing the progression we see it is a I minor changing to a IV minor. There is no IV major or II minor chords in this minor key progression so as per our rule we can play D Aeolian mode over all the chords. D Aeolian is the same as F major, (minor & relative major). So play all the F major scales but remember to start on and emphasize the D notes and make that the tonal center D and it will sound minor and that is what you want in this minor key progression. If you emphasize the F notes it will sound major and not very good as this is a very minor sounding progression. D Aeolian = F major)

-Try landing on the hip chord tones when the change comes up. Chord tones are defined as the notes that make up a given chord. Write out the notes in each chord if you don't know them.

The D minor chord contains the chord tones D (root), F (b3rd), and A (5th) and the G minor chord contains the chord tones G (root), Bb (b3rd), and D (5th). When the chord changes to the Gm try landing on a G, Bb, or D note. Listen to how strong those notes sound. They sound so strong because they are strong notes that make up the chord you are playing over, the Gm. Do the same thing when the chord changes to the Dm chord and at the change to Dm land on a D, F, or A note. Hear the strong chord tones? – it's a big wow and makes killer strong solo statements.

The non chord tones that are in the scale you are using will surely still work and sound good, but the chord tones may sound better. So think of it like there is good and then there is also better.

-As an exercise try landing on a different chord tone each time the chords change. It will really get you ear dialed into strong landing notes. When changing to the Gm first time around try landing on the Bb note and then second time around try landing on the D note when the change goes to the Gm chord. Next time around at the change land on the G note. Listen to how strong those chord tones are and time to hit the note right when the chord changes. Then try landing on one of the Dm chord tones when changing to that chord. Landing on the root, b3rd, or 5th really kills! Try it and really listen to the chord changes underneath so you can time you change exactly and make a bold solo statement.

KEY POINT: Remember to always examine the notes in each chord of the progression to determine the hip landing notes when changing chords.

EXAMPLE PROGRESSION 2: Dm to G major

By analyzing the chords we determine we are in the key of D minor. The progression is a I minor chord, Dm, to a IV major chord, G. Lay this change down with a slow groove and two measures per chord.

***What Relates to all the chords:**

-Try D Minor Pentatonic & Blues scales over all the chords. Remember that's the default setting – since we are in the key of D minor, with no major V chord, we know that D minor Pentatonic & Blues will always work over all the chords all day long.

-Try D Dorian mode over both chords as it relates to all. After analyzing the progression we see it is a I minor changing to a IV major chord. Looking at our minor key rule for playing over all the chords we see there is a IV major chord in this minor progression so we can play D Dorian mode over all the chords. D Dorian is the same as C major, but you have to emphasize D notes to sound minor. So play all the C major scales but remember to shift to the root of the mode, D, so start on and emphasize the D notes and make that the tonal center. D Dorian = C Major.

-Try landing on the hip chord tones when the changes come up.

-D minor chord contains the chord tones D-F-A

-G major chord contains the chord tones G-B-D

EXAMPLE PROGRESSION 3: Am7 to Bm7

Here we are in the key of Am and examining the chords we have a Im chord changing to a II minor chord.

***What Relates to all the chords:**

-Try A Minor Pentatonic & Blues scales over all the chords as it relates to all.

-Try A Dorian mode over both chords. Looking at our minor key rule when soloing over all the chords we have a II minor chord so we want to solo over all chords with the A Dorian mode. A Dorian is the same as G major. So solo with all your G major scales but start on and emphasize all the A notes. A Dorian = G major.

-Try landing on the hip chord tones when the changes come up.

-Am7 chord contains the chord tones A-E-G-C

-Bm7 chord contains the chord tones B-F# -A-D

KEY POINT: Keep in mind that at this stage of your lead guitar playing there is just no substitute for studying and listening for the sounds and relationships between chords, intervals, and scales.

The critical key in unlocking all the potential of these scales and modes is in learning their interval structure and memorizing the rules above for when it is appropriate to apply each in a given soloing scenario. Another key as I discussed earlier is listening and studying the relationships between chords and scales. Examine each interval structure as listed in the table below.

Major scale, (Ionian mode)	1 (root)	2	3	4	5	6	7
Natural Minor scale, (Aeolian mode)	1 (root)	2	b3	4	5	b6	b7
Dorian mode	1 (root)	2	b3	4	5	6	b7
Pentatonic Minor scale	1 (root)	-	b3	4	5	-	b7
Blues scale	1 (root)	-	b3	4	b5	5	b7

As you can see the Dorian mode is very similar to the Natural Minor scale with the exception that the sixth degree is not flattened. In other words the Natural Minor scale has a minor 6th, while the Dorian mode has a major 6th. There is just one half step difference between these two scales. Although C major and D Dorian contain the same notes, their interval structure is different. This is what gives each its own unique sound. Dorian and Natural Minor also contain the same intervals as Minor Pentatonic, but adds the 2nd and 6th or b6th degrees.

This is why when you are playing Minor Pentatonic over all the chords in a minor key progression usually Aeolian or Dorian mode will also work over all the chords. Try it and mix them up and switch back and forth, you will be very pleased at the new tones. Just analyze the chords and follow the above key points to determine which mode, Aeolian or Dorian, will work over a given song or progression.

THE MINOR PENTATONIC EXPANDED I SCALE

Let's build on the minor pentatonic basic box shape scale that you learned in the previous page. We are now going to expand the scale two frets in each direction combining three of the box shapes. We are still going to play the same five-note scale. However, the expanded scale exudes a much more fluid sound and sets up many additional and different combination runs and licks than just staying solely in the "box" shape. You certainly want to have all the pentatonic scales in the box patterns in your arsenal, but this expanded scale you will find really opens the pathways and lead guitar avenues a lot further. Commit it to memory and practice it in all keys. You will find yourself using these expanded scales all the time when playing in the pentatonics – they are invaluable.

Expanded I Minor Pentatonic Scale

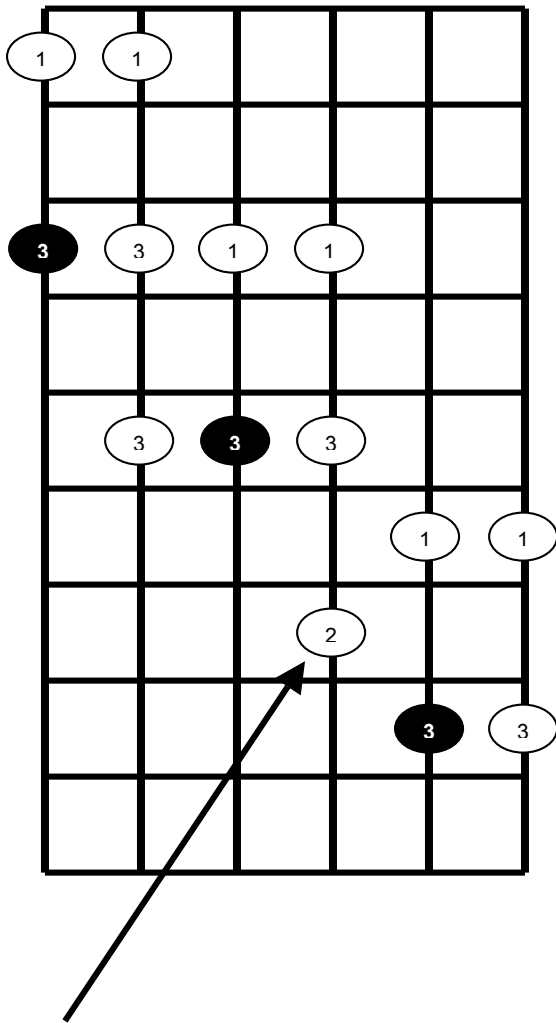

Analyzing this expanded scale you can see part of the basic box pattern you learned in the previous page encapsulated in the middle of the shape. The shape is expanded two frets in each direction using the neighboring two boxes. Now you have a Pentatonic shape that **doubles** the fret span of the basic box pattern.

As always when learning a new scale, take your time and play the scale slow and in time. Sound each note clean, with no string buzzes or overtones. As you move through the scale make a mental note of when you hit the three root notes, (illustrated with the black circles). Practice the scale utilizing the fingerings illustrated. Notice the shift in fingering when you get to the G-string. There is a one – three – two finger combination. Utilize your second finger when playing the third note on the G-string as that will set you up for the two and three note combinations and licks to be played with the G, B, and high E strings. As always, you want to utilize the proper fingerings that set you up for the next lick, run, or chord.

Much like the first pentatonic scale in the basic box pattern the key signature for the expanded scale is determined by which root note is played on the 6th string. Play that note with your third finger. For example if you play this shape starting at the fifth fret on the low E string it is the Expanded I **A** minor pentatonic scale consisting of the five notes A, C, D, E, and G. If you were to play this scale starting with your 3rd finger on the 10th fret it would be the Expanded I **D** minor pentatonic scale consisting of the five notes D, F, G, A, and C. Practice this scale in all keys up and down the fret board.

For the G string pivot with your **second finger** for the 1,3,2 fingering combination

KEY POINT: You can grab these above two scales fast if you memorize the two above scales as:

1. Basic Box Position Minor Pentatonic Scale – 1st finger root on the low E string
2. Expanded I Minor Pentatonic Scale – 3rd finger root on the low E string

THE MINOR PENTATONIC EXPANDED II SCALE

Now that you are familiar with the Minor Pentatonic scale in the basic box position and in Expanded I form, lets learn the Minor Pentatonic Expanded II scale. This scale will have its root note on the 5th or A string and you can start with your 3rd finger. Illustrated below is the Expanded II Minor Pentatonic scale. With both Expanded scales and the basic “box” shape you can cover just about the entire fretboard. Practice these scales in all keys up and down the fret board. Commit them to memory, as you will find yourself grabbing them all the time.

Expanded II Minor Pentatonic Scale

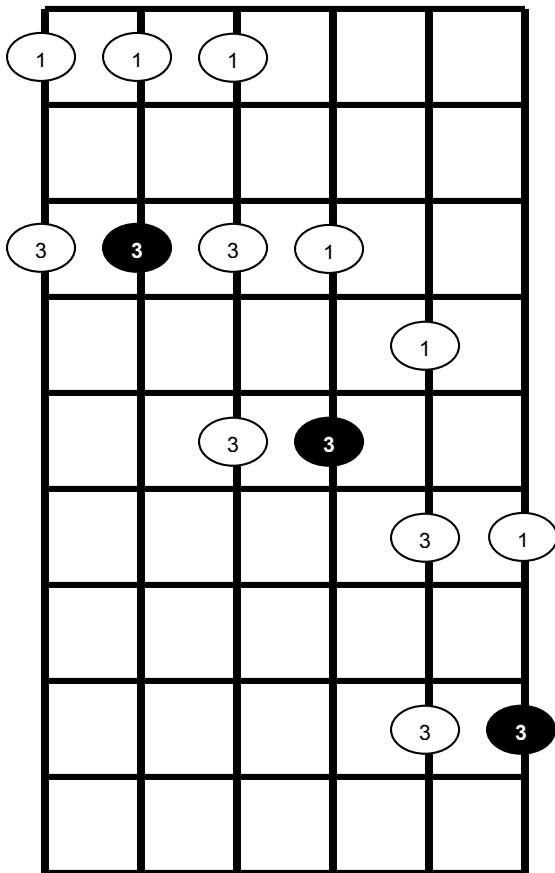

Take your time when first learning this scale pattern, and play the scale slow and in time. Sound each note clean, with no string buzzes or overtones. As you move through the scale make a mental note of when you hit the three root notes, (illustrated with the three black circles). Practice the scale utilizing the fingerings illustrated and work up this expanded scale in all keys. Just use the first and third fingers to play the entire scale.

In this Expanded 2 scale the key signature is determined by which root note is played with the third finger on the on the 5th or A string. That is how you can find all the different scales quickly, by identifying the root notes. For example if you play this shape starting at the tenth fret on the low E string it is the Expanded II **A** Minor Pentatonic scale consisting of the five notes A, C, D, E, and G. This is due to the root note being played on the 12th fret of the A string – an “A” note. If you were to start this scale on the 12th fret of the low E string it would be the Expanded II **B** Minor Pentatonic scale.

KEY POINT: You can grab the above scales fast if you memorize the three above scales as:

1. Box Position Minor Pentatonic Scale – 1st finger root on the low E string
2. Expanded I Minor Pentatonic Scale – 3rd finger root on the low E string
3. Expanded II Minor Pentatonic Scale – 3rd finger root on the A string

THE MINOR PENTATONIC SCALE – the 5 box scales

Illustrated below are five common box shapes for the Minor Pentatonic scale. I usually find myself playing the expanded I and expanded II scales more often, but you should know all 5 box positions so you can utilize the entire neck. Practice these in all keys and remember to make mental notes where the root notes lie. Start learning the scales below in the key of Am as they line up across the fretboard nicely and you can start the number 1 box with your 4th finger on the 5th fret of the Low E string on the A note.

Commit all the shapes and notes to memory and you will soon be gliding across the neck in Pentatonic heaven. Remember, it is critical to memorize what notes you are playing, not just the shapes. You want to be able to pick out and land on any given note depending on what chord changes you are playing over. Too many times guitarists just memorize shapes and forget what notes they are actually playing. So spend time learning the notes in all keys and you will benefit greatly with this extra work. These box shapes will give you many different riff ideas and runs. You will find them to be quite useful. Remember to practice and learn these scales in all keys and practice linking them together. Soon you will be able to see the entire fretboard mapped out as one large scale that travels up and down the entire neck.

#1 box – in Am start with 4th finger on the 5th fret, low E string on the A note.

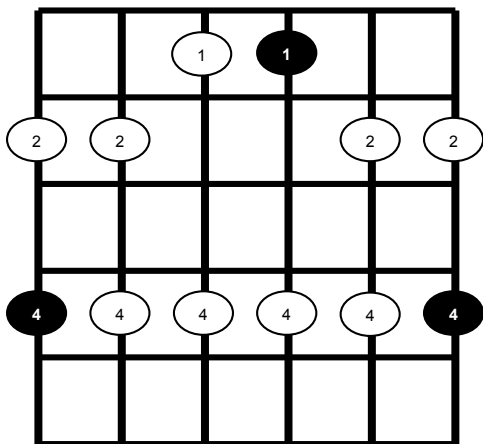

#2 box – in Am start with 1st finger on the 5th fret, low E string on the A note. (the basic box shape)

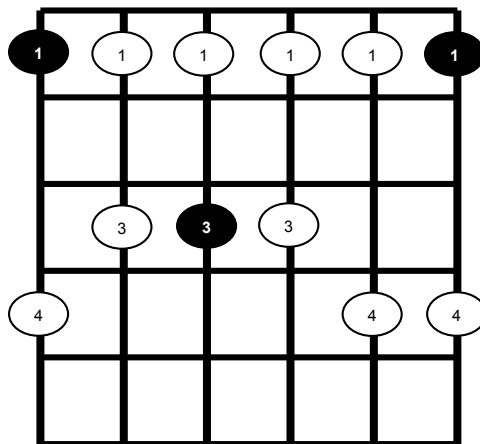

#3 box – in Am start with 2nd finger on the 8th fret, low E string on the C note. (these first three boxes make the Expanded 1)

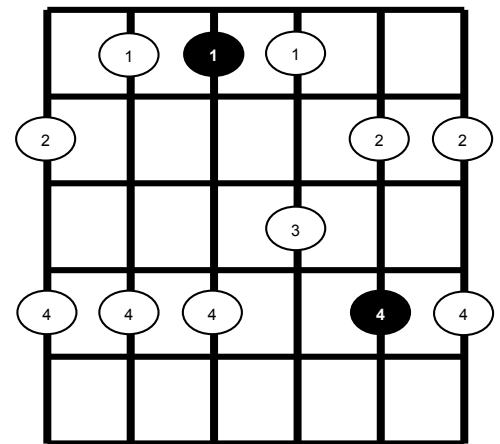

#4 box – in Am start with 1st finger on the 10th fret, low E string on the D note.

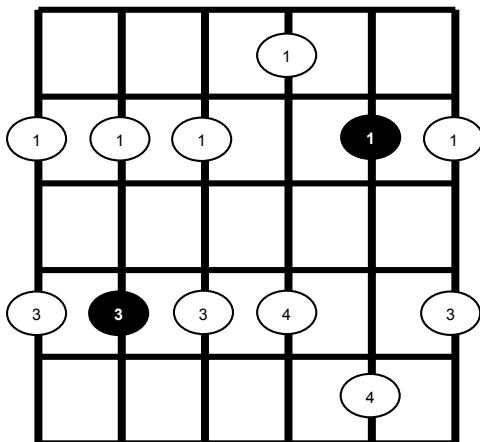

#5 box – in Am start with 1st finger on the 12th fret, low E string on the E note. (these last two boxes and the first one combine to form the Expanded 2 shape)

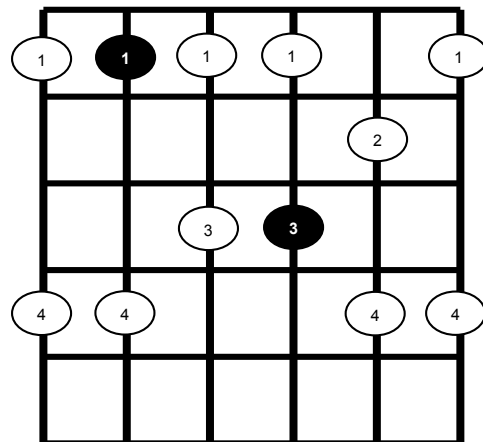

THE MINOR PENTATONIC BLUES SCALE

The Blues scale is basically a Minor Pentatonic scale, with one added note, the flatted 5th, or blue note. The b5 creates a certain amount of color and tension that is extremely useful. The blues scale is not solely utilized in blues music but rather is used in many musical genres including rock, country, jazz, pop, metal, punk, and more. Adding this scale to your lead guitar arsenal will definitely add a little “bluesy” color and texture to your playing. Use it pretty much whenever you play Minor Pentatonic scales. Now we will make it the Minor Pentatonic Blues Scale. This is the scale when you hear the term “blues scale” tossed around.

By adding the b5 note we now get the six-note scale constructed from the degrees of 1, b3^d, 4th, b5th, 5th, and b7th. The first illustration below on the left is the basic box shape Minor Pentatonic scale. Directly below that we add the b5th and now have the Minor Pentatonic blues scale. They only differ by one note, the b5th or blue note, illustrated in blue. The illustration below to the right is the Expanded I Minor Pentatonic Blues scale.

A common challenge with many students is that they always play and think of scales in box patterns and they stay in one box, then stop, move to the next box, then stop, and so on. This can have a real boxy and fragmented sound with lines that have no continuity. Students benefit greatly by learning to play ACROSS the neck by playing laterally. The ultimate goal is to see the entire neck as one big inter-connected scale. Then leave them all connected and just move the whole chunk back and forth as one chunk, to change key. These expanded scales will pull you out of the traditional boxes that can have a boxy sound that many players cant seem to leave behind.

As always, utilize consistent fingering and practice these scales in all keys and learn all the scales up and down the neck. Then apply them by practicing your soloing over the jam tracks. Make strong solo statements by emphasizing strong chord tones and root notes. Employ good phrasing and continuity, and play laterally across the neck. Rock on!

Basic Box Minor Pentatonic Scale

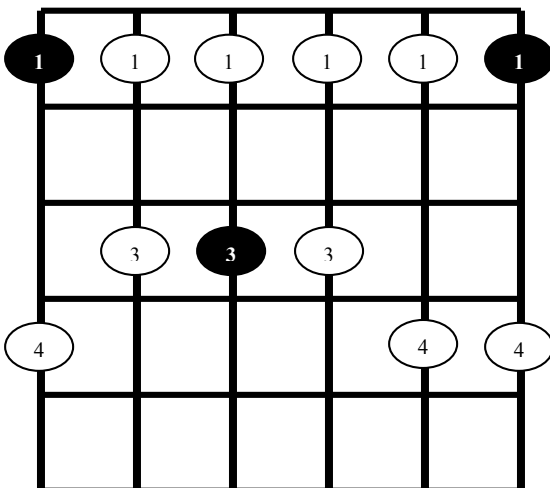

Minor Pentatonic Blues Scale

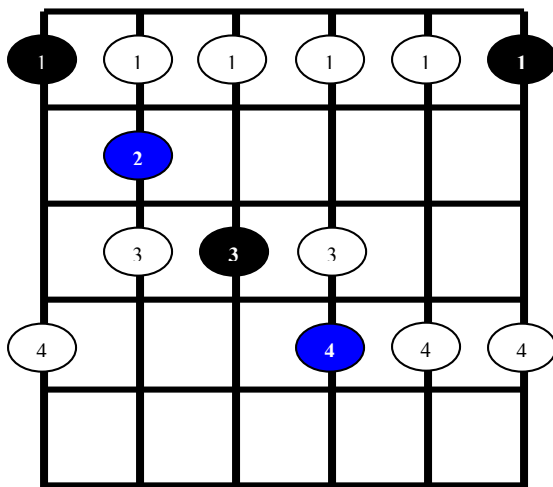

Expanded I Minor Pentatonic Blues Scale

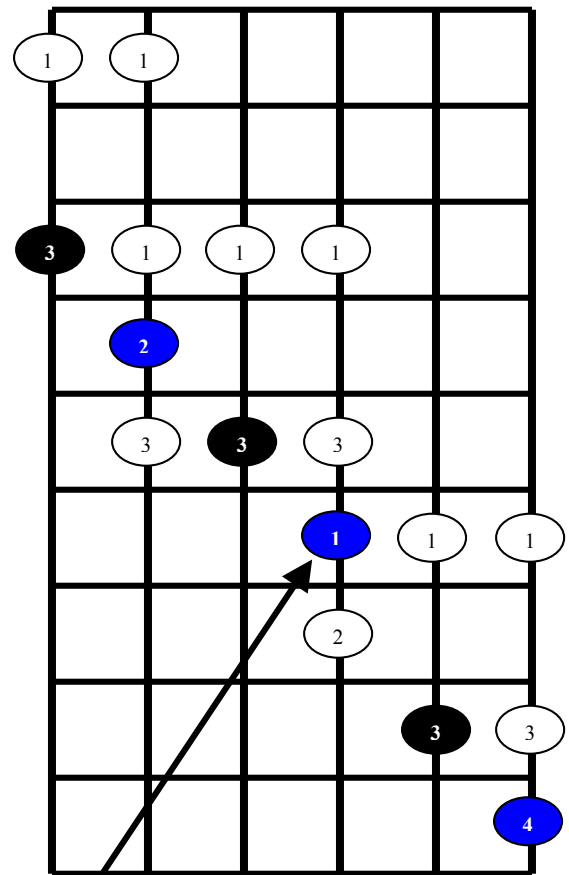

When ascending the scale at the G-string pivot with your 1st finger playing 1,3 then 1,2. Then descending use a 3,2,1,1 finger combination on the G string

● = root note ● = blue note (b5)

THE MINOR PENTATONIC BLUES EXPANDED II SCALE

Let's continue to add the b5th, or blue note, to the Minor Pentatonic scale in the Expanded II scale. Below on the left is the Expanded II Minor Pentatonic scale. By adding the blue note we now get the Expanded II Minor Pentatonic Blues scale, as shown below on the right. There is only one note added to make the Blues scale. Examine the fingering carefully as it varies slightly between the two scales. The fingering shown below puts your fingers in the proper place on the fretboard to set up for the next part of the scale, or if playing a solo, the next lick. Remember it is crucial to always have your fingers in the right position, setting yourself up for the next lick or run. Practice the scales below in all keys.

When playing through these scales remember to make mental notes when hitting the root notes and the blue notes, as you may want to emphasize these notes in your lead lines - its all about emphasis! Also remember, as I always state, just don't memorize the fingering for scales or just the scale shapes. Take the extra time to learn the notes and intervals that you are playing in a given key. Taking a little extra time to do this will make you a much better musician in the long run.

Expanded II Minor Pentatonic Scale

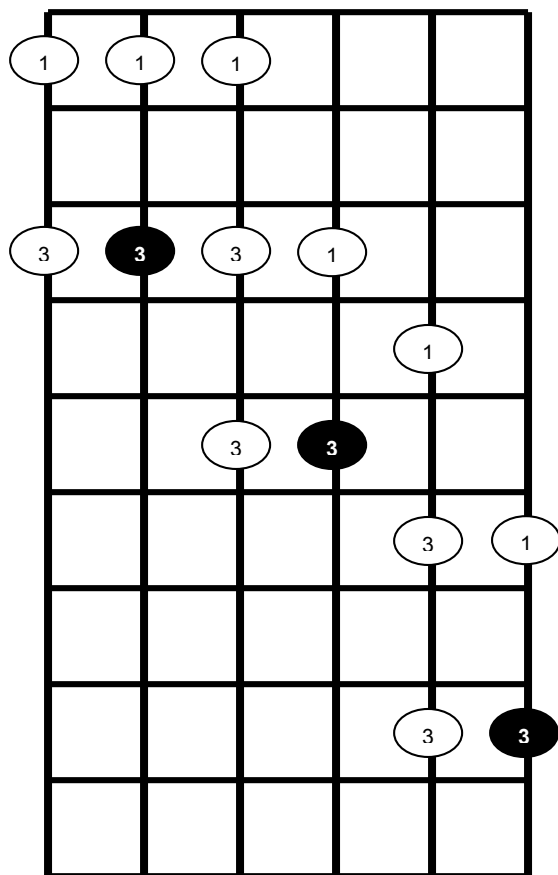

Expanded II Minor Pentatonic Blues Scale

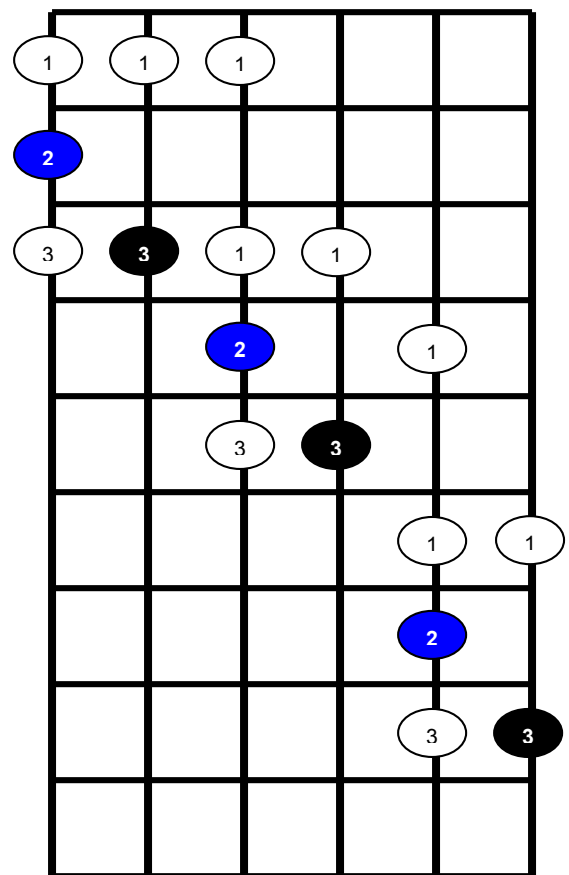

THE MINOR PENTATONIC BLUES SCALE – ALL FIVE BLOCK SCALES

Below are the five box shape Minor Pentatonic Blues scales. This now completes the entire neck in Minor Pentatonic Blues scales. All the holes and gaps are now filled and you want to work towards playing the Minor Pentatonic Blues scale over the entire neck. Practice the Blues scales in all keys and try and connect them with the rest of the shapes so you can play up and down the entire neck. Connect them in with the Expanded I and II Blues scales. Remember, try to see the connection points and the neck as one big scale and play laterally across it – not always just as all individual boxes.

#1 box – in Am start with 4th finger on the 5th fret, low E string on the A note. Go outside for the blue note on the D string

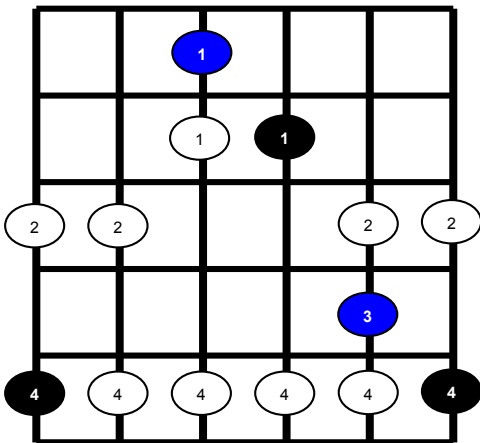

#2 “basic box” shape – in Am start with 1st finger on the 5th fret, low E string on the A note. Use 2nd and 4th fingers for blue notes

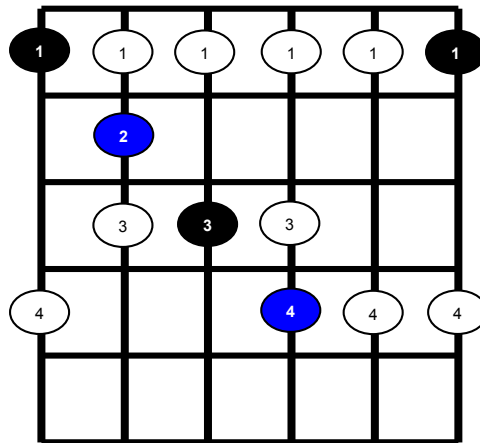

#3 box – in Am start with 2nd finger on the 8th fret, low E string on the C note. (the lower part of this box is that mini box in the expanded I scale)

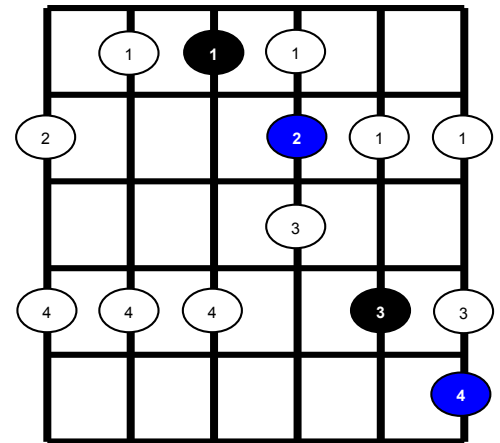

#4 box – in Am start with 1st finger on the 10th fret, low E string on the D note. First three strings are first part of expanded II scale

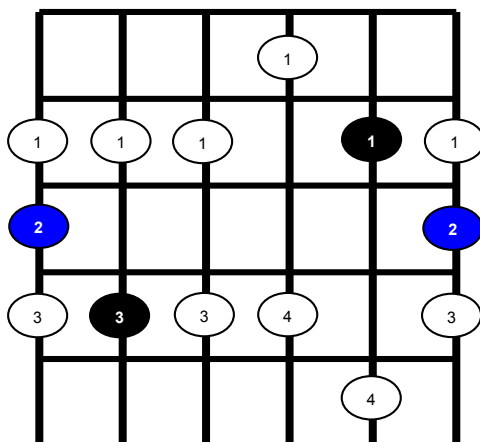

#5 box – in Am start with 1st finger on 12th fret, low E string on E note. (last two boxes and the first one combine to form expanded II scale)

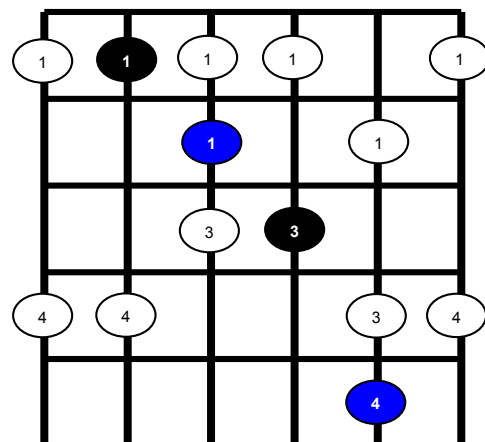

SPICING UP THE MINOR PENTATONIC BLUES SCALE

Now that you have learned some Pentatonic scales lets look at how we can spice things up a bit to add some more color and texture to your playing. Its not enough just to know the scale but you will need to take the notes and do musically interesting things with them. Think of guitar playing as speaking a language. We are going to turn our notes, or words, into sentences. This is what some refer to as phrasing - the way we connect and play our thoughts musically on the guitar. What's so important in great lead playing and improvisation is engaging your audience and drawing them into your playing. You want to speak to your audience musically in a way that is engaging and that they can comprehend. So it's so important that your musical thoughts and phrases make musical "sense". For instructional purposes we are going to use the Minor Pentatonic basic box shape to illustrate these techniques. In the illustration below the black ovals are the root notes, the white ovals are the other notes in the scale, and the colored ovals are the various notes we will discuss below.

1. Spice it up by doubling and tripling up on your notes. Don't always go from one note to the next to the next in straight eighth or quarter notes. You have to bust them up a bit to make them sound more interesting. Play the same note in rhythmic combinations. Ba.Ba.Ba...Ba...Bow – remember, if you can say it, you can play it! Feel the rhythm of the line, don't just play it straight – and say the phrase out loud if you need to. Then change around the rhythm. Get into an idea that you like and keep repeating it, perhaps playing it a little different rhythmically each time. Learn a rhythm or rhythmic phrase and then apply it to some of your favorite licks across all the strings. So when you are noodling around and get into a little cool idea – keep it – keep playing it – turn the rhythm around and exploit it and keep repeating the phrase. Remember rhythm, repetition, and melody are the keys!

2. Spice it up by slurring your notes with passing tones. Slide into your notes utilizing half steps passing tones. It is a great sound as you get the inference of the passing tone and then the target note. Do not hang on passing tones and don't try and bend or vibrato them – get on and off them quickly, just use them in passing. Bookend your passing tones with two strong scalar notes. For example, if you are playing a five-note Pentatonic scale, you can utilize the other seven notes as passing tones. Just remember to get and off them quickly and bookend them with strong notes that are in the scale. Try utilizing the passing tones in the diagram to the right. Slide from any note in red to the scale note one half step higher. The note in blue is the blue note, or b5, and makes a great note to use as a passing slide tone also. Double and triple up on these slides. These slurs will add some great color and interest to your playing.

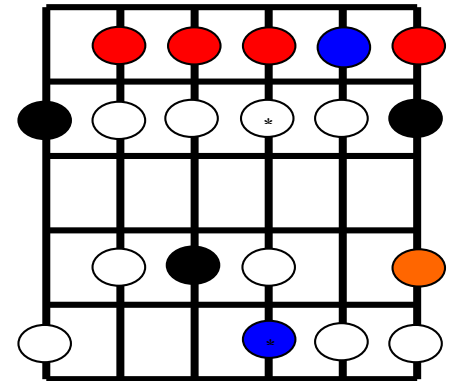

3. Spice it up by adding the ninth scale degree to the Minor Pentatonic scale, (the ninth is illustrated above as the orange oval). This note sounds great and will work most of the time when using minor pentatonic adding much color to the scale. It is a great note to slide off, bend a half step, use in triplet patterns, and use in pull off and hammer licks. The outside sounding note will give you a little jazzy sound. So bend it a half step or slide from the ninth to the next note, the b3rd. It's a great sounding note! Also use the 9th on the G string – more cool licks!

4. Spice it up by slightly bending the b3rd on the G-string, (the b3rd is a white oval with an asterisk, "*"). The b3rd is a very ambiguous note, especially when playing the blues. It sometimes sounds best when played as a natural tone and sometimes sounds great bent up a quarter or half step depending on what chord its being played over or that you go to next in the progression. Pull that b3rd note down in a nice bend and really feel it. Slur in and out of it and you will find it will add a lot of texture to your playing. If you are playing in the box shape it is one of the few times where I like to bend with my first finger. It's an easy bend as you are only going up a quarter or half step so you don't need multiple finger strength to reach and hold the pitch. You can bend it slow or fast, but put a lot of feeling and passion into this bend and you will absolutely love the sound! One of the few bends where you have some leeway and don't have to bend it exactly perfect – anywhere in that quarter to half step range sounds great.

5. Spice it up with reverse slides – instead of always sliding a note up the fretboard try sliding down the fretboard. A real nice reverse slide is to slide the blue note one-half step back to the fourth. In the diagram above reverse slide from the blue oval with the asterisk back one half step. Really feel the slide and hear both notes. Repeat the slide two or three times in succession for a real cool riff. So try sliding in both directions not just limiting yourself to sliding up the neck.

The MAJOR PENTATONIC SCALE

The Major Pentatonic scale is a five-note scale consisting of five notes from the Major scale. It is an extremely useful scale that has a very sweet major sound. At times full major scales may be inappropriate to play over a given progression, as they may sound a bit stiff. The major seventh note is a very "ify" note, especially in rock music as sometimes it works and many times it doesn't. Defaulting to the Major Pentatonic scale for that major sound in many of these instances is a great idea and will give you a killer sound.

The five-note Major Pentatonic scale is derived from five notes from the Major scale similar to how the Minor Pentatonic scale is derived from five notes from the Natural Minor scale. The intervals of the Major Pentatonic are 1,2,3,5,6. You do not play the 4th and 7th degrees of the Major scale.

For many guitarists there's confusion surrounding the Major Pentatonic and it's relative minor, the Minor Pentatonic scale. The Minor Pentatonic is the relative minor of the Major Pentatonic and lives a minor 3rd, or three frets away, below the Major Pentatonic. For every major key there is a relative minor key. Both keys will have exactly the same notes. Refer to the handout on the circle of fifths on page 49 for a complete listing of every major key and its relative minor key.

Illustrated below is the "basic box shape" C Major Pentatonic and its relative minor, A Minor Pentatonic. C Major Pentatonic scales can also be viewed as A Minor Pentatonic scales. Both scales consist of the same notes C, D, E, G, and A. Your starting and emphasis notes determine which scale will sound. The confusion often comes because of the multiple names. C Major Pentatonic and A Minor Pentatonic are the same scale, just different starting and emphasis notes. Just like when playing utilizing the modes, it all comes down to what notes you are emphasizing - emphasis is so important!

Play both scales starting and ending with the root and listen to how the Pentatonic Major sounds very sweet and major sounding when starting on and emphasizing the C notes. Play the same shape but start and end on the A notes. Now you get the darker bluesy Minor Pentatonic scale. Same notes, just different start and emphasis points. One scale gives you the happy, major, Allman Brothers/BB King type of sound while the other gives you a darker, bluesy, minor type sounds.

Remember that you can get to all the Major Pentatonics by going through the relative Minor Pentatonic scales. So you don't have to learn any new shapes for Major Pentatonic if you already know your Minor Pentatonic scales. Just flip them to their relative Major Pentatonic.

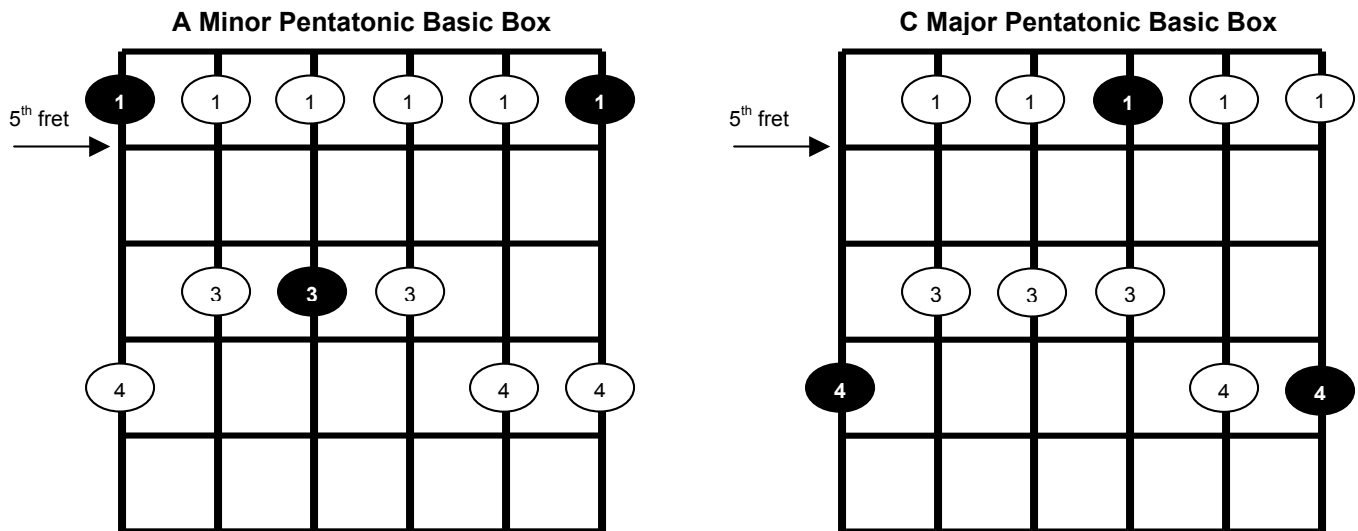

If you know your Minor Pentatonic scales across the entire fretboard there is no need to learn any new shapes to play Major Pentatonic. You can get to those shapes from the relative minor Pentatonics. Learning more shapes would be redundant.

The blue note does not always apply to Major Pentatonic and often will not sound very good. So use the straight Minor Pentatonic scales and Expanded scales without the blue notes. There is not as much room for error soloing in major key either - bad notes really stick out. You also can't slur all those passing notes like we discussed when using Minor Pentatonic. So be careful with your note choices and let your ear help to guide you. So think of it like you have a bit more leeway in Minor Pentatonic than you have in Major Pentatonic. But, I will teach you a few ways to spice up Major Pent in the coming lessons.

For that sweet Major Pentatonic sound utilize all of your Minor Pentatonic shapes focused on emphasizing the root of the mode – the major. For example, when playing in C Major Pentatonic think of the relative minor, A Minor Pentatonic shapes that you have learned previously. Just start and emphasize on the C notes, not the A notes. You want to sound major so you have to emphasize the major root notes, not the minor ones. Practice in all keys and all positions up and down the neck.

Major Pentatonic Sus4 Scales

A very cool way to spice up the Major Pentatonic scale is to add the fourth degree to the scale. Instead of it being a five-note scale it will now be a six-note scale. Adding the fourth degree makes it a **Major Pentatonic Sus4 scale**. The intervals of the scale are now 1, 2, 3, 4, 5, and 6. Basically it's a major scale with the 7th degree left out. This scale works just about every time so try using it when playing in Major Pentatonic.

In the past lesson we discussed that the major 7th is a very "ify" note. This is true especially in rock music as sometimes it works and sometimes it doesn't depending on the underlying chords. What is great about the Major Pentatonic Sus4 scale is that it leaves that major 7th note out all together. This way you don't have to worry about it at all and you get the added bonus of a real sweet sounding Sus4 note added into the scale. Try this scale over simple major key jams and ballads at first to get the fingerings down and make sure make a mental note each time you pass through the root AND the Sus4 notes.

In the illustration below the root notes are in the black and the Sus4 notes are highlighted in yellow. This is the basic "box" shape that you have seen in previous lessons. As discussed above this Major Pentatonic shape can be viewed as the same notes as its relative Minor Pentatonic.

This scale gives you many additional lick ideas as you have three notes per string with the half step on the A and B strings in the shape below. A great bend is on the B string bending up to the Sus4 note with a nice half step bend with the first finger. Very sweet sounding bend.

Major Pentatonic Box Shape

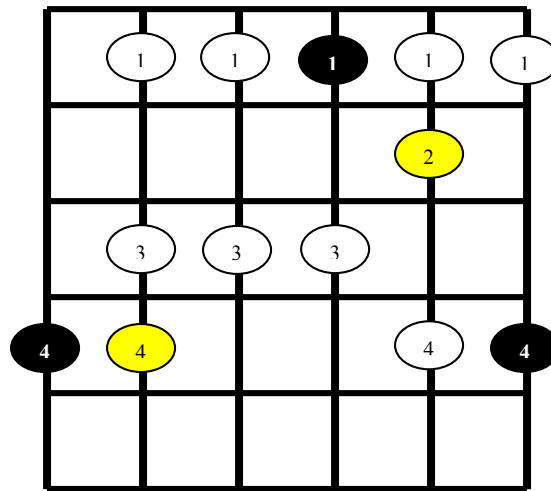

Example: Try playing a simple progression of C to F, two measures on each chord. That is a I major to a IV major change and its in the key of C major. Because we are in major key, instantly we know major pentatonic will work. So C Major Pentatonic would sound very good played over this progression. But for added spice play the C Major Pentatonic Sus4 scale.

If you analyze the chord changes in the key of C the 4th is an F. This change goes C to F. So the Major Pent Sus4 scale would be an awesome choice to play as it adds that F note.

In fact you will often see I major to IV major changes, they are very common. That is why the sus4 scales are so useful. Try to feel when the change happens and land on the strong chord tones of the chord changes. The strongest landing notes on the C chord will be the notes in that chord, C, E, or G. The strongest landing tones on the F chord will be the notes making up an F chord, F, A, or C. Practice your timing landing on a different chord tone each time the change comes up. Learn the long form Sus4 scale links on the next page and work all the scales over the entire fretboard in all keys.

Major Pentatonic Sus4 scale links

Major Pentatonic Sus4 Expanded 1

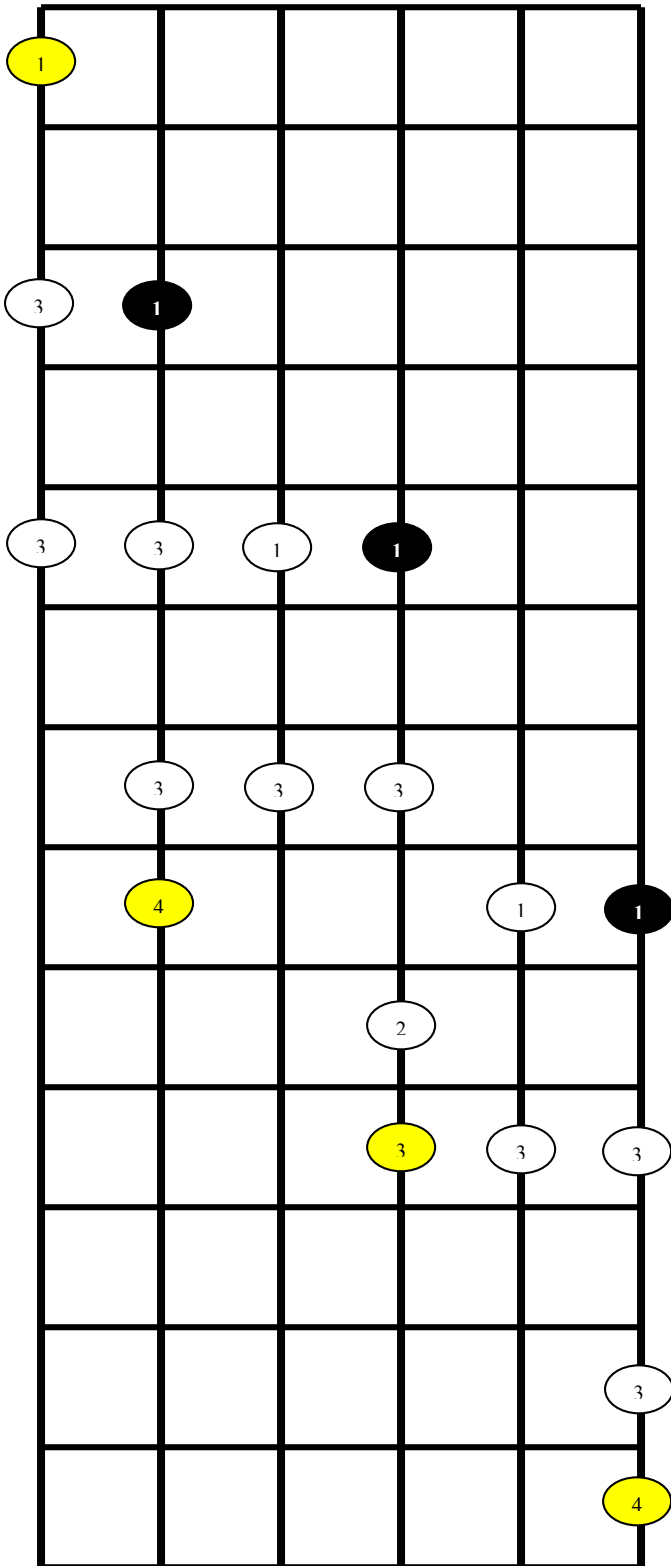

Major Pentatonic Sus4 Expanded 2

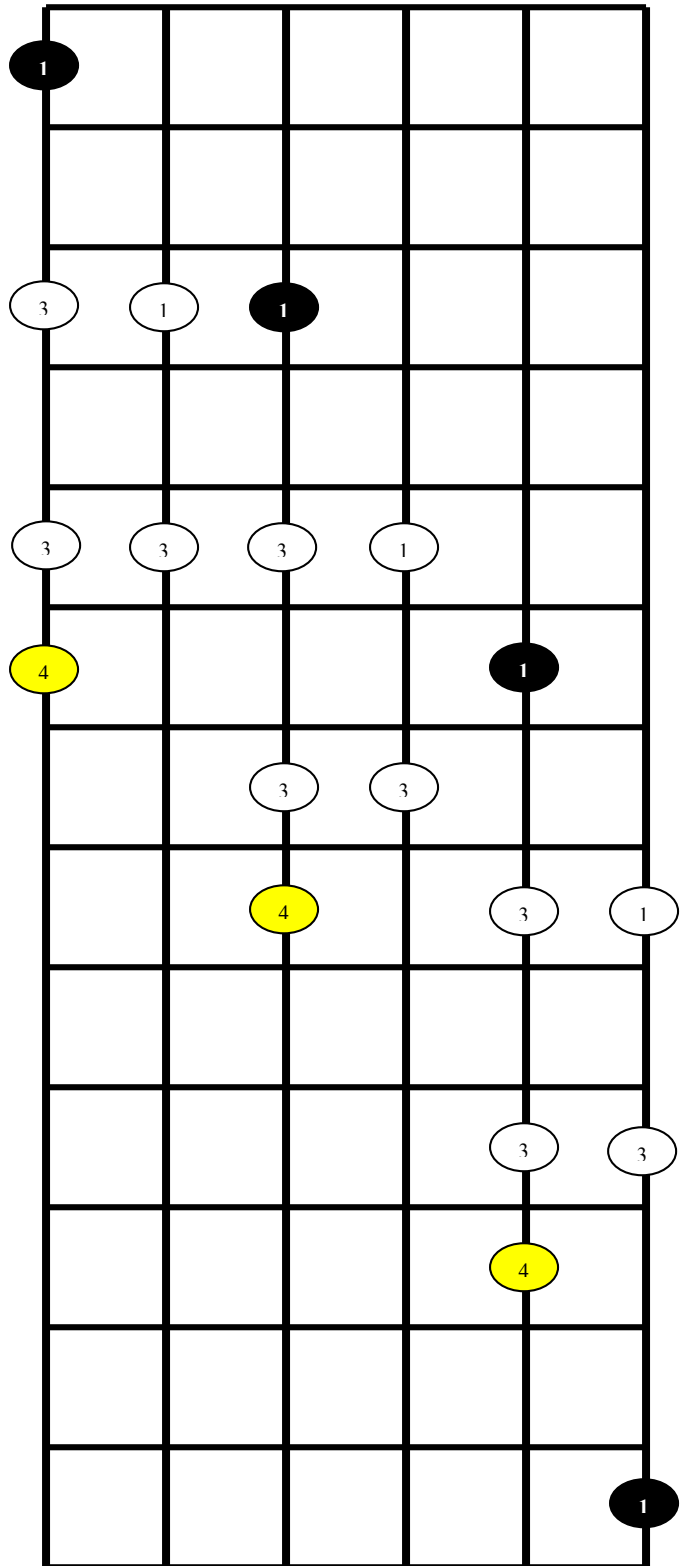

● Root notes in black

● Sus4 notes in yellow

THE MAJOR SCALE

All music theory compares back to the major scale. The major scale is the elemental constant that all other scales are compared. You are probably familiar with the sound of a major scale – doe, re, mi, fa, so, la, ti, doe. There are many different fingerings and ways to play major scales all over the guitar neck. Over the next two pages you will learn a system of six major scales that I have found students gravitate to the fastest. With all six memorized, you can utilize the entire guitar neck. The scales overlap each other and you need to note this as that is how we will get you started linking them together – through these overlaps, or link points.

The major scale is constructed from seven notes built from the scale degrees of 1, 2, 3, 4, 5, 6, 7. Memorize the scales one at a time and take your time and play the scales slow and in time. As you move through each scale make a mental note of when you hit the root notes, which are illustrated in black. The key signature for each scale is determined by the root note. For starters learn the scales below in the key of G. So to play the #1 scale in G major put your 2nd finger on the 3rd fret on the low E string, (G note) and play the shape. You will now be playing a G major scale which consists of the seven notes G, A, B, C, D, E, and F#. To play scale #2 in G put your first finger on the G note on the low E string at the 3rd fret and play the shape. Much like moveable bar chords these scales can be moved up and down the guitar neck and should be practiced in all keys. It is essential that you know these major scales cold and are comfortable moving them around in all keys. On page 39 you will learn to link these scales together so you can start to view the neck as one big scale. You will see the overlap and how they fit together. Then just move the WHOLE block of scales up or back to change key. If you know your major scales you will then know all the modes of the major scale as they are just variations of the major scale. It's critical to get these scales down cold!

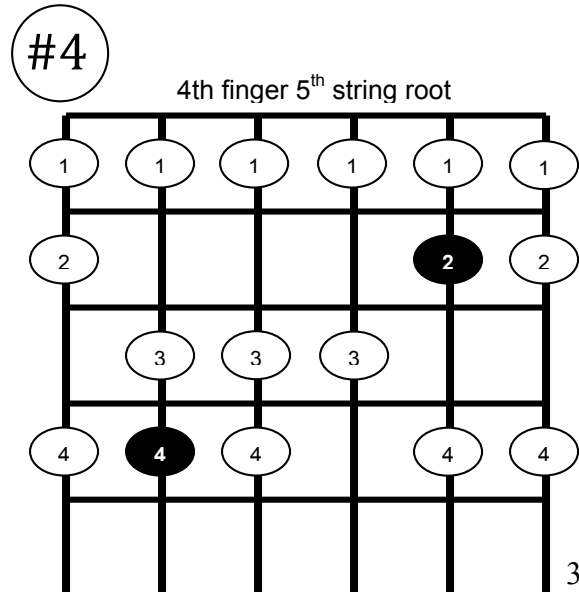
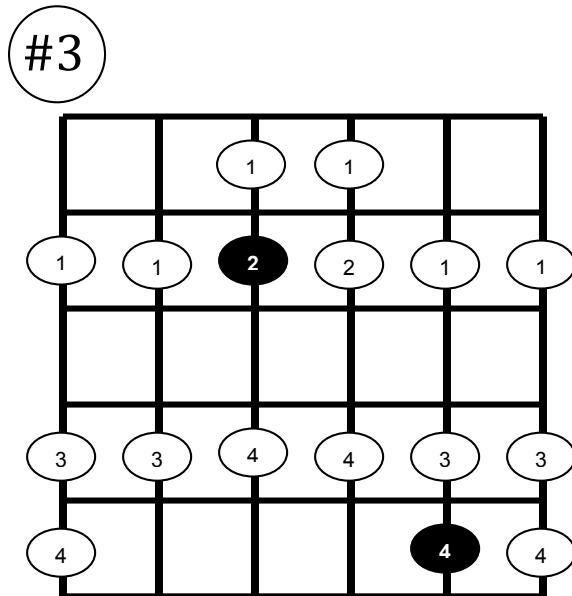
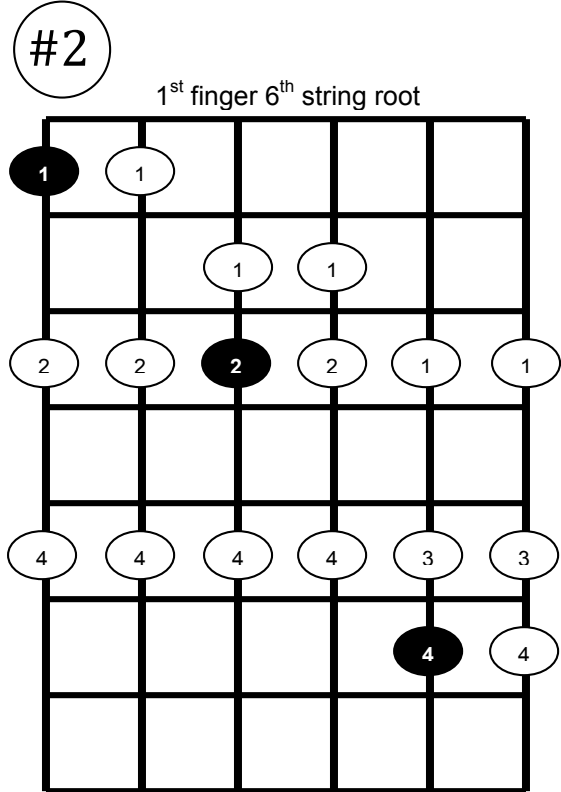
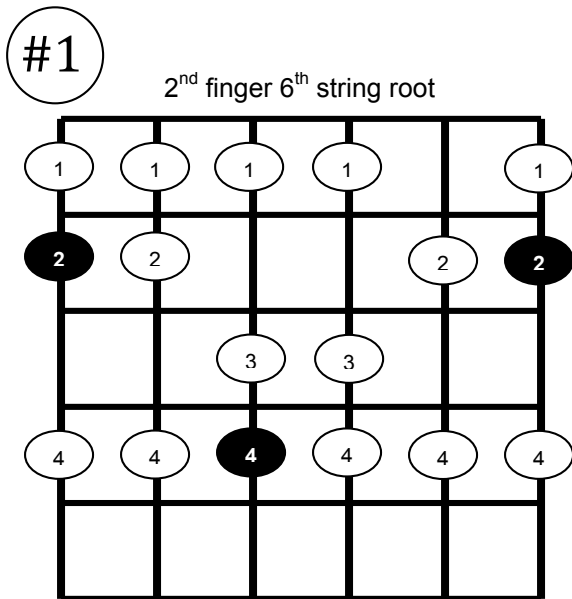

THE MAJOR SCALE SHAPES FIVE AND SIX

#5

2nd finger root 5th string

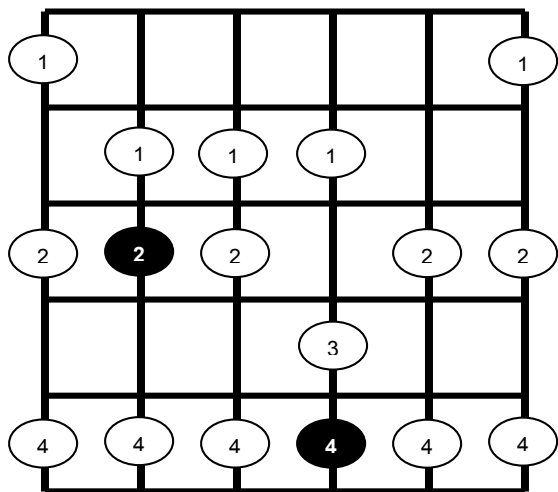

#6

1st finger root 5th string

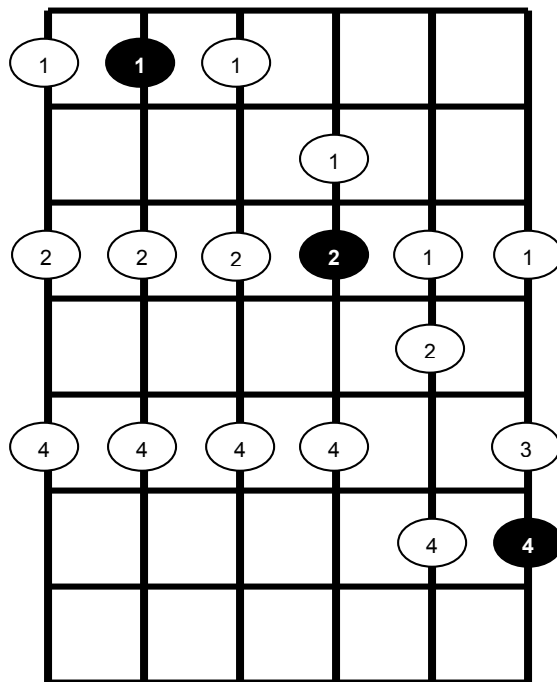

MAJOR SCALE LINKS

Now that you know six major scales from the previous page, lets start to link them together to start playing across the neck. This will get you viewing the entire neck as one big scale. You need to have this “vision” to see how the whole set of six connect together as that allows you to phrase them together while going in and out of each. Below are two examples of three octave major scales that combine three shapes. These are incredibly useful and are a great visual tool to start visualizing the entire fretboard as one big shape. These examples will also help you to practice playing laterally across the neck. You will need to shift with your first finger for both these examples when you get to the D and the B strings. Shift up a whole step, (2 frets), with that first finger for the 1-1 finger combination. Remember to practice in all keys.

The scale link on the left utilizes 1-2-4 fingering to play the entire scale link. Shift up with the first finger as indicated. The scale link on the right utilizes 1-3-4 fingering to play the entire scale link. Again shift up with the first finger as indicated. The scale links are awesome tools, be sure to practice in all keys.

3-octave Major scale link

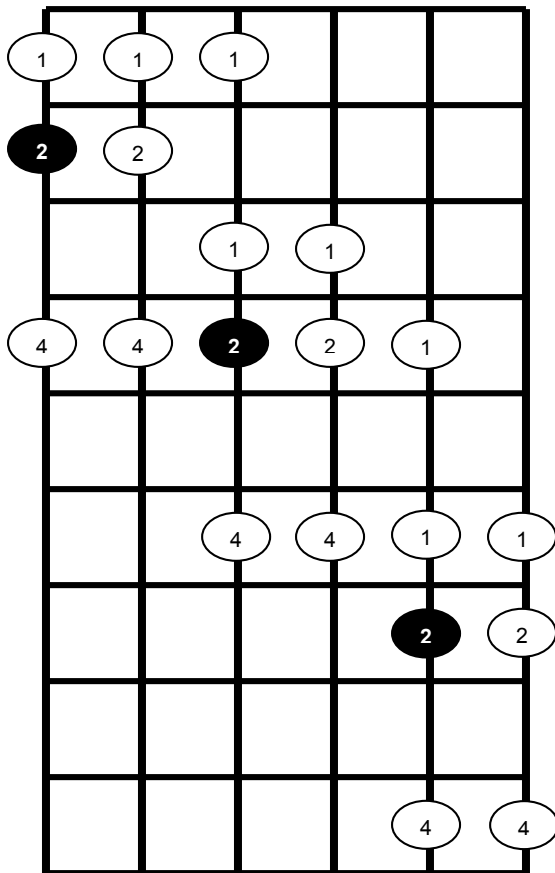

Links scales 1, 2, and 4

3-octave Major scale link

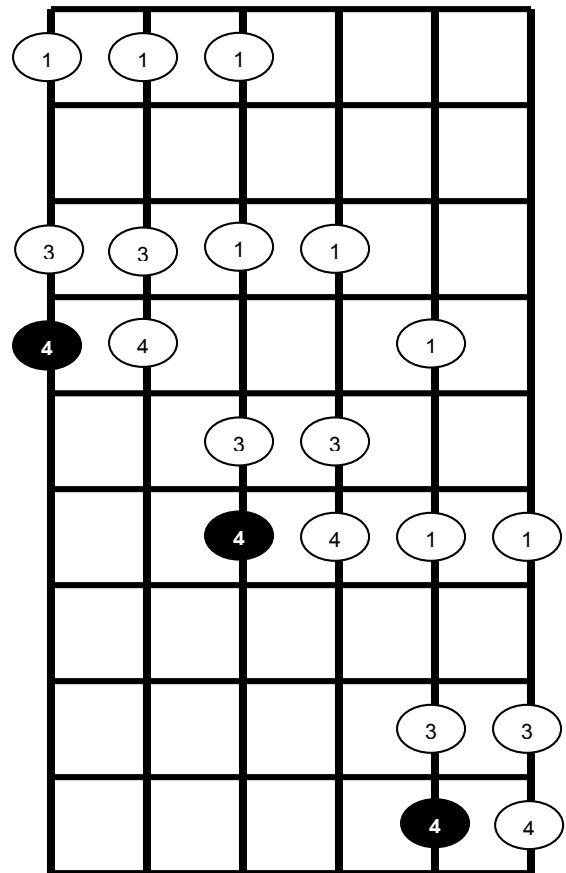

Links scales 6, 1, and 2

● = root note

○# Fingering to be utilized

THE MODES OF THE MAJOR SCALE - OVERVIEW

To get your lead playing to the next level eventually you will want to play in the modes. The modes of the major scale are all those Greek names you have probably heard of or read about previously in this book. The modes of the major scale in order are named Ionian, Dorian, Phrygian, Lydian, Mixolydian, Aeolian, and Locrian.

Don't let modal playing intimidate you. **Just think of the modes as just being variations of the major scale.** All you will be doing is starting on and emphasizing a note in the major scale other than the root note.

There is a general consensus in the guitar community that the modes are this real abstract and mysterious entity that you need a black belt in music theory to understand - that they are out of the reach of most guitar players. That is totally not true and I suggest to you that you can be playing in the modes very quickly if you put all that negativity about the modes aside. **YOU CAN DO IT** and I will help get you there.

In fact you already may be playing in the modes and not even realizing that you are doing it. I can get pretty much any lead guitarist playing in the modes in an extremely fast manner. In fact you will amaze yourself how fast you will be able to play in the modes with just a little understanding of how they work, how to apply them, and then practice applying them with jam tracks. It will take some time to master and get used to the modes, but every guitar player can play in the modes if they set the goal to tackle them.

In this lesson I will break down modal theory in digestible pieces. Others really overcomplicate the teaching of the modes and make it so much harder than it needs to be. I will make it easy. My modal methodology requires that you know your major scales. We will get at all seven modes through the major scale.

In the major scales lessons in this book I drew out six major scale shapes on pages 37-38. Those six shapes will get you across the whole neck. To play the modes of the major scale all you need to do is play variations of those scales and you will be playing in the modes.

KEY POINT: Just think of the modes as variations of the major scale.

Please see the lesson on major scales on pages 37-39 to learn six major scales and how to link them together. The killer thing with my methodology is that you don't have to learn a whole new set of scales for each mode. You don't have to learn a whole new set of scales for Dorian, then six more new scale shapes for Phrygian, then six more new and different scales for Lydian, etc. Learning six new scale shapes for each mode is totally redundant and totally unnecessary.

With my system, once you learn the six major scales, you know all the modes of the major scale because you will be using those same six major scale shapes to play all the modes. You will just be starting on any one of the six shapes on a note other than its root.

Before we can examine each mode of the major scale we need to overview the modes in general so you can have a clear understanding of their structure and sequence. This is crucial to understanding them and applying them in your playing.

As stated in previous lessons all music theory is compared back to the major scale. The major scale is the standard that all is compared to. The major scale is a seven-note scale - doe, re, me, fa, so, la, ti. For each of the seven individual notes of the major scale there is a different mode associated with it. There are seven notes in the major scale, so there are seven modes of the major scale.

There are seven modes in every major key and these modes always appear in the same order. Utilizing the modes gives the guitarist the ability to generate an interval structure that is different than that of the major scale and therefore produces a unique sound quality. Each mode has its own "mood", or sound quality due to the different interval structure of each mode. Some modes are more major sounding and some more minor flavored.

KEY POINT: To play in the modes you play a major scale but start on and emphasize a note other than the root of the major scale. Anytime you play a major scale and start and end on a note other than the root, you are playing in the modes.

Think of the modes as variations or inversions of the major scale. Illustrated below is the order for the seven modes. This sequence of the modes is **ALWAYS** the same. No matter what key you are in the modes always follow the order listed below. Dorian is always the second mode of the major scale, Phrygian is always the third mode of the major scale, etc., etc., – the sequence is always the same no matter what key you are in. Memorize this order and know it cold.

- 1st mode - **Ionian** (same as the Major scale)
- 2nd mode – **Dorian** (same as Aeolian but with a raised 6th)
- 3rd mode - **Phrygian** (same as Aeolian but with a b2nd)
- 4th mode – **Lydian** (same as Ionian but with a #4th)
- 5th mode – **Mixolydian** (same as Ionian but with a b7th)
- 6th mode – **Aeolian** (same as the Natural Minor or Pure Minor scale)
- 7th mode – **Locrian** (very dissonant, same as Phrygian but with a b5th)

For simplicity sake let's examine the key of C major which has no sharps or flats. Looking at the modal sequence above, Dorian is the 2nd mode of the major scale. In the key of C major if you start the scale on the 2nd degree or 2nd note of that C major scale, you will start on the D note – start on that D note and play that C major scale till the next D note comes up. So you are playing a C major scale from the D to the D notes. Viola - you have the D Dorian mode. All you are doing is playing that same C major scale but starting it on the 2nd note of the scale, the D. You are playing that C major scale from the D to the D.

D Dorian mode is the second mode of C major and utilizes all the exact same notes in C major scale but starting from the second degree, the D note. Look at it drawn out:

C Major scale – C,D,E,F,G,A,B
D Dorian scale- D,E,F,G,A,B,C

Same exact notes, just different starting points. It's just a variation of the C major scale. Play both as listed above from the C to C and then from the D to D. They don't sound the same at all. The C major scale sounds happy and has that do, re, mi sound while the D Dorian has a darker minor vibe to it. The Dorian has its own mood and sound quality that is different than the major.

So to play in D Dorian you can play all the C major scales but start on and emphasize the D notes, not the C notes. In D Dorian you want to establish the tonal center as D, so by emphasizing the D notes in a C major scale we arrive at a new scale sound that sounds different than C major because our ear hears the resolution to D. It sounds more minor because the Dorian mode has a b3rd and b7th.

Dorian is considered more of a minor mode, although you can use it in some major applications as I have taught in this book. C major and D Dorian are constructed from exactly the same notes, just take a C major scale and start and end on the D note and BLAMM...D Dorian. C Major = D Dorian.

To drive this point home let's look at the illustration below. Taking the C major scale and starting and ending on or emphasizing the D notes gives us the D Dorian mode. It has the exact same notes as a C major scale, just starting on the 2nd degree or note of the scale, D. Note below that D Dorian has no sharps or flats, same as C major. Dorian is the 2nd mode in any major key, so taking any major scale and starting on the 2nd note of that parent or mother major scale gives us the Dorian mode.

Scale degrees	1	2	3	4	5	6	7	8	9
C major scale	C	D	E	F	G	A	B	C	D
2nd mode – D Dorian		D	E	F	G	A	B	C	D

Dorian is an awesome mode to play in and it is used all the time in many genres of music including rock, blues, funk, metal, and jazz. So for purposes of the Rock Jam Tracks CD you really want to get good with the Dorian mode, as you will find yourself using it all the time. It is considered a minor mode, but it can be used in some major applications, as I will explain in other lessons.

Continuing in the key of C major let's examine the 3rd mode of the major scale, Phrygian. Same construction as we did above with the Dorian mode. From the order of modes listed above we know Phrygian is the third mode in any major key. Let's look at the C major scale and now we will start on the 3rd note of the scale because we want Phrygian and that is the 3rd mode. So for Phrygian just start on the 3rd degree of the major scale.

Third note of a C major scale is E, (the 3rd in the key of C is E). So for E Phrygian we would start on the third note of the C major scale or the E note. So now play that C major scale from the E note to the E note. You get another sound quality or mood – it's very different than the happy C to C major sound and also different from the minor D to D Dorian. The Phrygian, or E to E in C major sounds a bit more exotic, has a dissonant interval in it. Try it.

Now we add the third mode we just constructed to our diagram for Phrygian. As you can see from the illustration below C major, D Dorian, and E Phrygian are all constructed from the same notes.
C major = D Dorian = E Phrygian.

Scale degrees	1	2	3	4	5	6	7	8	9	10
C major scale	C	D	E	F	G	A	B	C	D	E
2 nd mode – D Dorian		D	E	F	G	A	B	C	D	E
3rd mode - E Phrygian			E	F	G	A	B	C	D	E

Phrygian is played starting on and emphasizing the E notes. The notes in each of the three above modes are the same but it's all about **EMPHASIS**. Which notes are you starting on and emphasizing gives you the different moods, and sound textures of each mode. Start on the C and play to the C for the happy major Ionian. Start on the D and emphasize the D notes for the bluesy minor Dorian. Start on the E and emphasize the E notes for the dark, minor, exotic Phrygian. Phrygian is also considered a minor mode and it has a very exotic sound. It's used often in rock and metal and sounds great over m7 chords.

KEY POINT: Remember when you start on and emphasize a major scale on any other of the notes than the root of the major scale, then you are playing in a mode.

If you start on and emphasize the 2nd note you are playing in the Dorian mode, (Dorian is the 2nd mode in any major key). If you start on and emphasize the 3rd note you are playing in the Phrygian mode, (Phrygian is the third mode in any major key). If you start on and emphasize the 5th note you are playing in the Mixolydian mode, (Mixolydian is the 5th mode in any major key). If you start on and emphasize the sixth note you are playing in the Aeolian mode, (Aeolian is the 6th mode in any major key).

Let's now add all the modes to the table we have been constructing using the key of C major. Listed below are all seven modes constructed in the key of C major. Notice in each mode below there are no sharps or flats, which is consistent with the key of C major. The Dorian mode begins on the 2nd degree of the C major scale, the D note. The Phrygian mode begins on the 3rd degree of the C major scale, the E note. The rest of the modes follow this same formula. Utilize this same formula to examine the modes in all keys and then we can start learning how to apply these modes to your lead playing and using them in your soloing and improvisation.

C Major	C	D	E	F	G	A	B	C
D Dorian	D	E	F	G	A	B	C	D
E Phrygian	E	F	G	A	B	C	D	E
F Lydian	F	G	A	B	C	D	E	F
G Mixolydian	G	A	B	C	D	E	F	G
A Aeolian	A	B	C	D	E	F	G	A
B Locrian	B	C	D	E	F	G	A	B

C Major = D Dorian = E Phrygian = F Lydian = G Mixolydian = A Aeolian = B Locrian. It just all depends on what notes you start on and emphasize in the parent major scale, in this example C major.

THE MODES OF THE MAJOR SCALE - INDIVIDUALLY

Now that you had a basic modal overview from the previous three page lesson we can discuss each mode in detail and how to go about utilizing them in your lead playing. In order to thoroughly understand the modes we will need to look at the interval structure that defines each mode and then match them with corresponding chords and progressions where they can be applied. **Remember that the modes are all just variations of the major scale and you will be playing the modes by shifting emphasis to a different note in the parent or mother major scale.** You can get to all seven modes through the major scales that you have previously learned.

The illustration below shows each mode in order and its interval structure. Many of the modes are very similar, some just one interval difference. For example the only difference between Aeolian and Dorian is the Aeolian mode has a b6 while the Dorian mode has a major 6th. Mixolydian is just like the Ionian mode or major scale but with a b7. Lydian is also like the Ionian mode but with a #4. Phrygian is just like Aeolian except it has a b2. So many of the modes are very similar but these slight differences will give you a totally different, unique mood with different sounds – it's absolutely amazing!

In the last column of the table it denotes which modes are considered more major modes and which are considered more minor modes. Memorize which are the more major modes, (Ionian, Lydian, and Mixolydian), and which are the more minor modes, (Dorian, Phrygian, Aeolian, and Locrian) as this will help guide you to utilizing the correct mode over a given chord or chord progression. Notice the asterisk on the Dorian mode.

1 st mode	IONIAN (Major)	1	2	3	4	5	6	7	Major mode
2 nd mode	DORIAN	1	2	b3	4	5	6	b7	Minor mode*
3 rd mode	PHYRGIAN	1	b2	b3	4	5	b6	b7	Minor mode
4 th mode	LYDIAN	1	2	3	#4	5	6	7	Major mode
5 th mode	MIXOLYDIAN	1	2	3	4	5	6	b7	Major mode
6 th mode	AEOLIAN (relative minor)	1	2	b3	4	5	b6	b7	Minor mode
7 th mode	LOCRIAN	1	b2	b3	4	b5	b6	b7	Minor mode

*Dorian mode is considered a minor mode but because it has strong elements of minor, (b3, b7), and major, (2,6), it can be played in some major key progressions. For example, use the Dorian mode over all the chords in a major key I-IV-V shuffle, blues, or swing type progression. Major key I-IV-V shuffles and blues are pretty wide open. You can use minor pentatonic for that minor bluesy sound, major pentatonic for that sweet major sound or to combine elements of both use the Dorian mode as it has elements of both major and minor and sounds great when used in this application.

Phrygian can also be used in some major key progressions that have a b2 chord. So there is lots of room for creativity with the modes, but learn the rules first,.....then you can have fun breaking them! Like with many lead guitar avenues sometimes you have to use your discretion and what sounds best to your ears.

Key points when applying the modes:

1.Understand your choices when soloing and improvising - When soloing and improvising you have two basic choices. You can solo over the entire chord string playing the same mode or scale over all the chords in the progression. This is called what “relates to all”. No matter what chord comes up in the string you are playing the same scale or mode over all the chords. The second option is to play over each chord independently. This is the type of playing I prefer as it give you a more sophisticated sound. It is definitely more challenging, and will take some practice to get the timing down of changing your scale, mode, or arpeggio over each chord. This is what I call treating each chord as a “separate event”.

2.Know and analyze the chords you are playing over - For lead playing the chords that you are playing over will provide the roadmap to what you can play solo and improvisational wise. Just knowing the key signature of the song is not enough to get you playing in the modes. You want to know what chords are in the progression and then analyze them to determine what scales, modes, and landing notes to utilize. For example, in minor key when playing over all the chords you need to look at if there is a IV chord, II chord or sometimes a V chord in a progression and are the chords major or minor. You need to know which notes make up the chords that you are playing over so you can use their respective chord tones as strong landing or emphasis notes. You will need to know the chords and their structure to fully understand and apply which mode you want to solo with because some modes sound best when played over certain chords and certain progressions.

APPLYING THE MODES OF THE MAJOR SCALE

Memorize these three steps for utilizing the modes over a given chord or progression (“ACE” principle):

1. **ANALYZE** the chords and/or the progression to get the roadmap for which modes you can utilize.
2. Once you derive which mode or modes to use, **CONVERT** that mode back to its mother or parent major key.
3. Play the mode using the parent major scale patterns but shift to and **EMPHASIZE** the root of the mode.

KEY APPLICATION POINT: Just remember “ACE” – Analyze, Convert, Emphasize.

When playing modally, think in terms of the mode that you want to utilize. To determine what scales and modes we can utilize within a given progression lets analyze the following chord progression, Am7–D. When starting modal theory, if possible, play a mode over the entire progression, play what relates to all. That is what you will want to get down first, and then later you can start working on treating each chord like a separate event. So with the below examples we will determine what mode relates to all the chords in a given progression.

STEP 1: ANALYZE the chords to determine what we can utilize solo and improvisational wise.

The progression is Am7-D. We are in the key of A minor, we have a I minor chord, (Am7), going to a IV major chord, (D). As soon as we see a I minor chord, (minor key), we know we can utilize Minor Pentatonic & Blues over all the chords, it relates to all. Analyzing the chords further we have a minor key progression where the IV chord, (D), is major. So we know according to our rules of soloing in minor key, that we can use the Dorian mode over all the chords. So we now have determined A Dorian will work over all the chords. Whenever you have a minor key progression you can almost always use either Aeolian or Dorian over all the chords. So always look for that IV chord or II chord when in minor key to determine what mode to use, (follow the guidelines for soloing in minor key on pages 23-25).

STEP 2: Once you determine which mode to use, CONVERT back to the mother or parent major scale.

We have determined to utilize A Dorian. Dorian is the 2nd mode of any major scale. So you have to ask yourself, what major scale’s 2nd note is an “A”? The answer is G major. The G major scale’s 2nd note is an “A”. So over this progression play all your G major scales up and down the neck but start on and emphasize the “A” notes and you have A Dorian. A Dorian = G Major.

STEP #3: Shift to and EMPHASIZE the root of the mode.

So we are going to play in A Dorian as we have derived from the **ANALYZING** and **CONVERTING** above. So then think A Dorian. **EMPHASIZE** all the A notes while playing G major scales. Visualize in G major and play those major scale patterns, but really emphasize the A notes, start on the A notes and go off from there. This is critical, because if you start on or emphasize the G notes you will be playing in G major, not A Dorian and it will sound major sounding and we don’t want that as here we are in minor key and what that Dorian minor key flavor..

Remember that each mode has its own “mood”, so you want to really exploit that and use the proper mode with the proper emphasis notes. You don’t want your lead playing to sound major in this instance as we have a very minor progression. We want that dark, bluesy, rock, minor vibe. So emphasizing the A notes making it A Dorian will give us just that. So much of modal playing is really all about emphasis.

KEY POINT: – Remember that you will also want to know the notes that make up each chord. You will want to get proficient at targeting these notes, or chord tones, as those notes, the roots, 3rds, b3rd if minor, 5ths, b7ths, etc. will be very strong landing notes, and you will want to target them.

Overall this is a very systematic and methodical system to analyze chords to determine what to play over them. Over time your ear will take you to the right notes but everyone should start out by systematically analyzing chords and progressions and writing them down. The three steps above are absolutely critical to have success playing in all the modes and you must be very proficient at each step. This will take a good amount of practice – but YOU CAN DO IT! Take things slow at first and it gets easier and easier the more comfortable you get with each step. At first try playing a mode over the whole progression, what relates to all the chords. Eventually you will want to play over each chord, or treat each chord as a separate event and play a different mode over each chord, but that will come later. Take your time and don’t overwhelm yourself. Try the examples listed under each jam track to work through some of the appropriate modes.

THE NATURAL MINOR SCALE (Aeolian Mode)

There is only one major scale but there are three types of minor scale - Natural Minor, Harmonic Minor, and Melodic Minor. Here we will examine the Natural Minor scale. The Natural Minor scale is a seven-note scale and the most common of the three minor scales. It is also called Pure Minor or Aeolian mode. All three terms for the scale are used, but when you hear just "minor scale", most often its natural minor that is being referred to.

The intervals in natural minor are 1,2,b3,4,5,b6,b7. The minor pentatonic scale takes its five notes from the natural minor scale. The natural minor scale then adds the 2nd and b6 to the minor pentatonic scale which gives you two additional notes to work with. The natural minor scale is very similar to the harmonic minor scale except the last degree is a flattened seventh, (b7). In the table below you can see how the natural minor scale intervals relate to some other common scales and modes.

Major scale, (Ionian mode)	1 (root)	2	3	4	5	6	7
Natural Minor scale, (Aeolian mode)	1 (root)	2	b3	4	5	b6	b7
Harmonic Minor scale	1 (root)	2	b3	4	5	b6	7
Dorian mode	1 (root)	2	b3	4	5	6	b7
Pentatonic Minor scale	1 (root)	-	b3	4	5	-	b7
Blues scale	1 (root)	-	b3	4	b5	5	b7

This is an awesome scale that you will want to incorporate into your lead playing. Play this scale over most minor type chords as well as over all the chords in some minor key progressions. You can utilize this scale in a minor key progression when soloing over all the chords unless the four chord is major, the two chord is minor, or there is a major V chord.

Below are two shapes for the Natural Minor scale that you will find incredibly useful. Number 1 has the low root on the low E string and number 2 has the low root on the A string. To play a B Natural Minor scale using the #1 shape on the left use your first finger on the B note on the low E string which is at the 7th fret and play the shape. To play a B natural Minor scale using the #2 shape use your first finger on the B note on the A string which is at the 2nd fret and play the shape. You just played B natural minor in two positions. Try playing these scales in different keys all over the neck – just move that root note.

You eventually want to learn the scale over the entire neck and learn all the notes in the scale, (I make this process easy by studying above modal lessons). These two shapes are a good starting point as they are easy to grab and go to get you started – just put that first finger on the root and go. Students find these shapes easiest at first because they start with the low root note with the first finger - easy and fast to find on the neck and blast the scale off. Commit these to memory and try them if they fit into the appropriate soloing opportunity. If you are just using minor pentatonic scales you really want to add these natural minor scales to your playing repertoire – they add the melodic half steps as well as provide infinite more lick and string bending opportunities. Get creative with them and try them as listed over the appropriate jam track on the rock jam track CD!

1. Natural Minor Scale low E string root

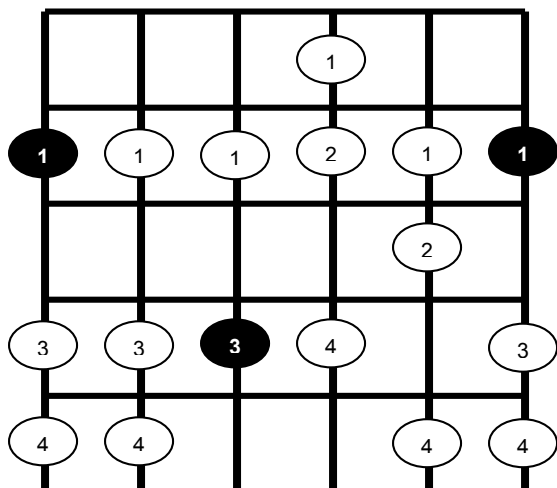

2. Natural Minor Scale A string root

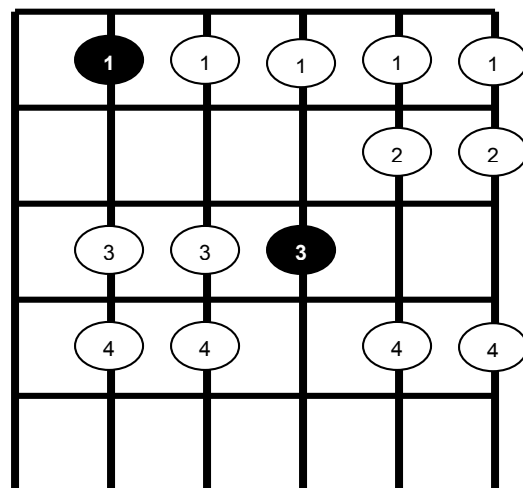

● = root note

○# Fingering to be utilized

THE DORIAN MODE

Remember that utilizing the modes of the major scale gives one the abilities to generate an interval structure that is different than that of the major scale and therefore produces a unique sound quality. The Dorian mode is the second mode of the major scale and utilizes all the notes in a major scale starting from the second degree. The Dorian mode utilizes the degrees of root or 1, 2, b3, 4, 5, 6, and b7.

Dorian is great for rock licks and can often be utilized over minor type chords and at times over all the chords in a minor key progression. If you play a lot of rock and blues you definitely want to add the Dorian mode to your arsenal of Pentatonic scales and the Aeolian mode. Below are a few Dorian scales that are easy to find just to get you going with this killer mode. Practice with Dorian over some of the jam tracks on the Rock Jam Tracks CD as listed in previous lessons.

In a previous lesson we learned that the 2nd degree of a C major scale is a D. So the D Dorian mode will contain all the same notes as the C major scale, you are just starting on the D note, (see example illustrated below). Notice for both scales there are no sharps or flats, which is consistent in the key of C major.

Scale degrees	1	2	3	4	5	6	7	8	9
C major scale	C	D	E	F	G	A	B	C	D
2nd mode – D Dorian	D	E	F	G	A	B	C	D	

Similarly, the second degree of an G major scale is an A. Following the same formula, the A Dorian mode contains all the same notes as the G major scale, you are just starting on the A note. Notice for both scales below there is only one sharp, the F#, which is consistent in the key of G major.

Scale degrees	1	2	3	4	5	6	7	8	9
G major scale	G	A	B	C	D	E	F#	G	A
2nd mode – A Dorian	A	B	C	D	E	F#	G	A	

The Dorian mode is very similar to the Aeolian Mode, (natural minor), with the exception that the sixth degree is not flattened. In other words the natural minor has a minor 6th, while the Dorian mode has a major 6th – just the one half step difference between these two scales. The Dorian mode is a minor sounding mode, kind of rock and bluesy, also very soulful and sophisticated. It contains all the same intervals as a Minor Pentatonic scale, but adds the 2nd and 6th degrees.

Let's break it up into smaller pieces and examine two fingerings for the scale. Below illustrates two shapes for the Dorian mode with root notes off the Low E and A and strings. Remember not to think of "shapes" or "positions" as modes. You want to get in the habit of looking at the entire fretboard as the vehicle for the mode, not just a certain position. Try to work up to the point of learning the mode and its interval structure across the entire fretboard.

1. Dorian Scale Low E string root

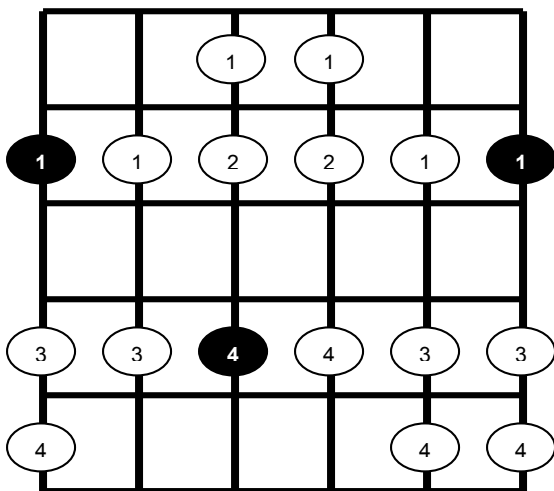

● = root note

2. Dorian Scale A string root

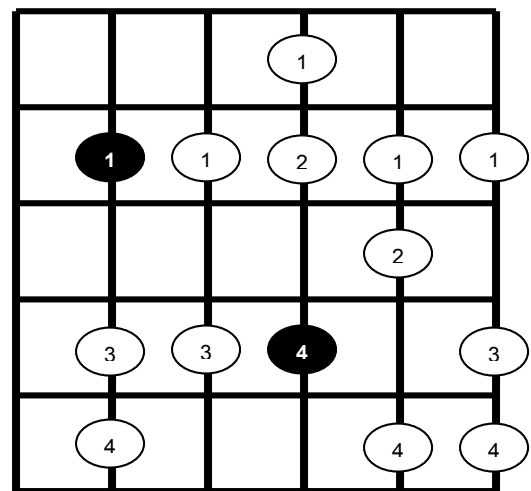

○# Fingering to be utilized

THE HARMONIC MINOR SCALE

There are three types of minor scales - natural minor, harmonic minor, and melodic minor. The harmonic minor scale is a very interesting sounding scale that will add color and depth to your sound. It is a very exotic sounding scale with a very distinctive color to its sound, almost Spanish or Middle Eastern sounding.

The scale is basically a natural minor scale with a raised seventh. The scale degrees are 1,2,b3,4,5,b6,7. The Natural Minor scale, or Aeolian Mode, is the same scale except the last degree is a flatted seventh, (b7). This form of minor scale is called "harmonic minor" because when harmonies are constructed in minor-key music, it often tends to utilize the raised 7th, especially in dominant harmony.

In the key of C the harmonic minor scale would consist of the notes C, D, Eb, F, G, Ab, and B. In the table below you can see how the harmonic minor scale intervals relate to some of the other scales and modes that we have discussed in previous lessons. This scale sounds great when played over a major V chord in a minor key progression or over minor plus seven chords, (minor/maj7). Also used often over dominant chords like the V7. You can play the scale over straight minor chords, but it will sound a bit exotic, as that 7th is such a strong note.

Major scale, (Ionian mode)	1 (root)	2	3	4	5	6	7
Natural Minor scale, (Aeolian mode)	1 (root)	2	b3	4	5	b6	b7
Harmonic Minor scale	1 (root)	2	b3	4	5	b6	7
Dorian mode	1 (root)	2	b3	4	5	6	b7
Pentatonic Minor scale	1 (root)	-	b3	4	5	-	b7
Blues scale	1 (root)	-	b3	4	b5	5	b7

KEY POINT: Soon as you see a V major chord in a minor key jam, BAMM – hit that V chord with Harmonic Minor

Just to get you started below are two scale shapes. You can grab these easily in any key as you grab the root note with your first finger on the 6th string root in the one shape and the 5th string root in the other. These will get you started but over time learn the scale over the entire neck and practice in all keys.

Harmonic Minor Scale off the 6th string root

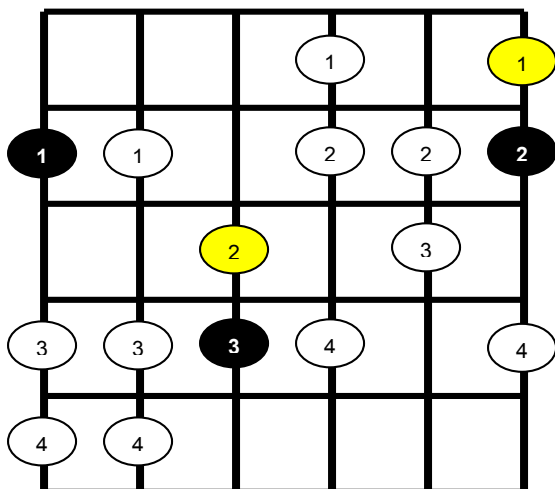

Harmonic Minor Scale off the 5th string root

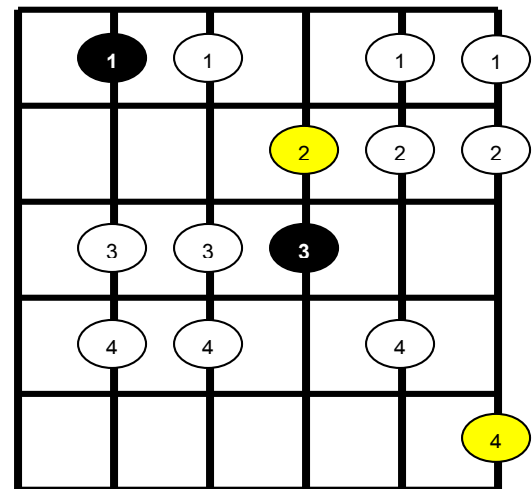

● root note

○ # Fingering to be utilized

● 7th degree of scale

Harmonic Minor 3-Octave scale link

Below is a three-octave Harmonic Minor scale link that will take you over half the neck. This will start to get you attaching the shapes and playing across the neck. You can play all three octaves utilizing a 1-3-4 fingering. Slide up with that 1st finger to play the strings with the 1-1-3-4 fingerings.

Practice this link in all keys and memorize the root notes and that key major 7th note as you will want to often resolve to that note, especially over the V chord in a minor key jam. But certainly experiment with the scale as some like to use it over minor chords especially in metal or hard rock playing scenarios.

KEY POINT: Remember that the critical note in the Harmonic Minor scale is that 7th – and that note is always located a half step behind the root. So if you know your root notes the 7th is very easy to find as just back up a half step.

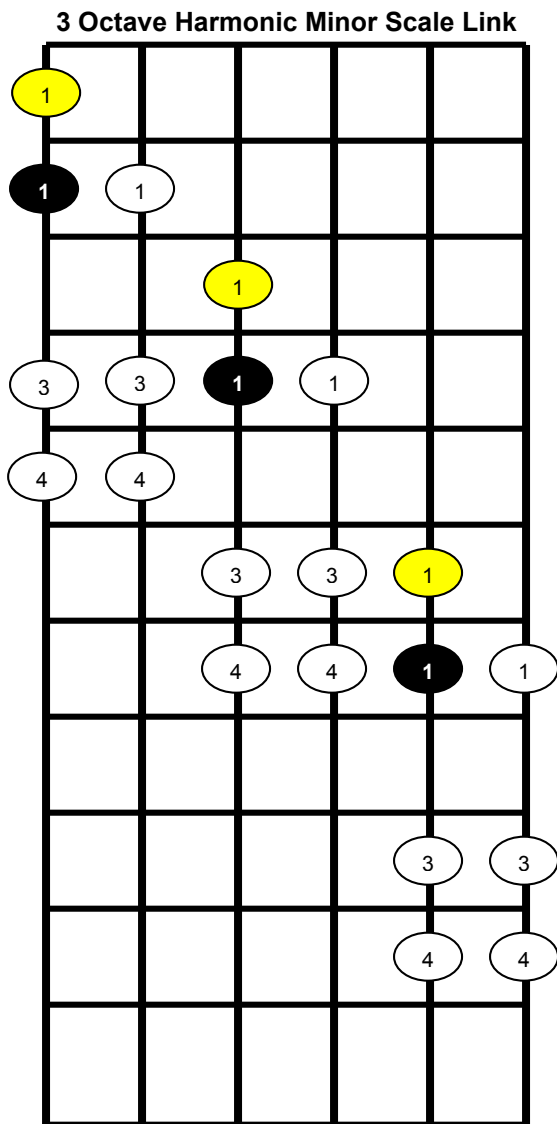

● root note

○ # Fingering to be utilized

● 7th degree of scale

GET STARTED PLAYING ARPEGGIOS

Lets get started with a few basic arpeggios. Arpeggios are notes of a certain chord or scale played one after another instead of strummed all at once. Arpeggios are the notes that make up chords, but played individually, or one at a time. Many times they are played from the lowest sounding note to the highest sounding note. Arpeggios are quite useful as they can be utilized throughout your soloing and improvisational lead lines, you can build riffs out of them, or create melody lines with them - the sky is the limit. And they can sound awesome in rock licks!

I have found the key to being able to phrase your arpeggios fluidly into your playing is being able to grab them quickly – knowing where they are at and what scales they live in so to speak. So in this lesson we will examine arpeggios that have first finger roots or pinky roots on the 6th or 5th strings. I have found students are able to grasp these the fastest and insert them fluidly into their playing. You certainly want to learn the arpeggio in all positions, much like your scales, but to get started these are what I have found students grab the fastest.

Another key to good arpeggio playing is mixing them in with your scales, modes, and riffs – not necessarily just playing a certain arpeggio up and back as that can get very sterile sounding. So try and mix them together with your modal or other scalar lead lines, that's how they sound best in my opinion – mixed in. Another key when playing arpeggios is that you want to be sure you are playing one note at a time. You don't want the arpeggio to sound like a chord strummed all at once – you want to kind of infer the color of the chord with the arpeggio. So kill each successive note after it is played. Do this by muting the strings.

Sometimes when playing certain arpeggios you will have to utilize the same finger for two or more strings as you move down or up the arpeggio. This is crucial especially if you want to eventually get into sweep picking. You want to try and “roll” your finger down the strings from one string to the next. The rolling motion of the finger works the best as opposed to barring your finger when playing arpeggios. This rolling of the finger technique produces a much smoother sound and the notes don't bleed into each other and contaminate the pure arpeggiated sound. This technique takes a little while to get the motion down, but keep practicing and it will come in time. The examples below are a basic major, minor, and minor 7th arpeggio. You can grab them in any key by grabbing the root note off the 5th string, (A string), with your pinky finger or first finger for the minor 7th.

A major chord is constructed from the intervals of root or 1, 3rd, and 5th degrees of the major scale. To play a major arpeggio just play those three notes, 1,3,5, one at a time and then repeat as per the illustration below. A minor chord is constructed from the intervals of 1, b3, 5. Play these three notes one at a time and you have a minor arpeggio. Then add the b7 to the minor for a minor 7th. Once familiar with the fingerings, practice the examples below in different keys all over the neck utilizing the shapes below just move the root note along the 5th string and find the root with your pinky. Try these arpeggios over the jam tracks as listed.

Now apply these by playing the major arpeggio over a major family chord and the minor arpeggio and minor 7th over a minor family chords. Arpeggios add so much color over their corresponding chords. ROCK ON!

major arpeggio - 1,3,5

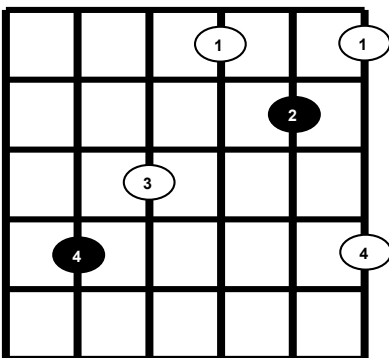

minor arpeggio - 1,b3,5

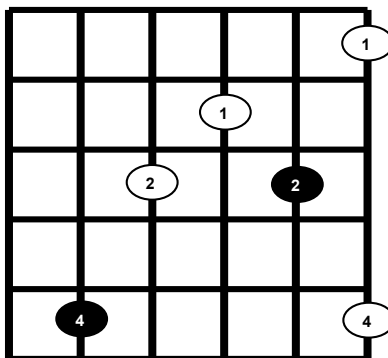

m7th arpeggio - 1,b3,5,b7

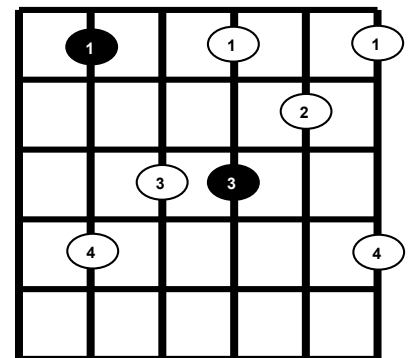

PLAYING ARPEGGIOS AND MODES OVER EACH CHORD

Lets apply what we have been learning to a four-chord progression. This progression is not on the Rock Jam Track CD but will be easy enough for you to lay down as it makes a great practice example. Play the chords slowly with two measures per chord. As discussed previously you must analyze the chords and the progression as that is what gives the roadmap to what you can utilize for soling and improvisational purposes. We have a I – VI – II – V progression in the key of D major. All the chords below are common to the key of D major so you can utilize the D major scale over the whole progression as D major **relates to all** the chords. In fact D major scales sound very good over all the chords – try it. Another avenue is to play over each chord individually with a different scale, mode, or arpeggio. Below are some suggestions of a few scales, modes, and arpeggios that work over the given chords. There is a myriad of options and I list a few to get you started, so get creative. Remember to listen carefully for the chord changes and try to end your phrases on strong chord tones. Mix things and play through the changes at first with a scale that relates to all and then switch and practice playing over each chord. This is a great exercise to practice playing over each chord independently, treating each chord as a separate event.

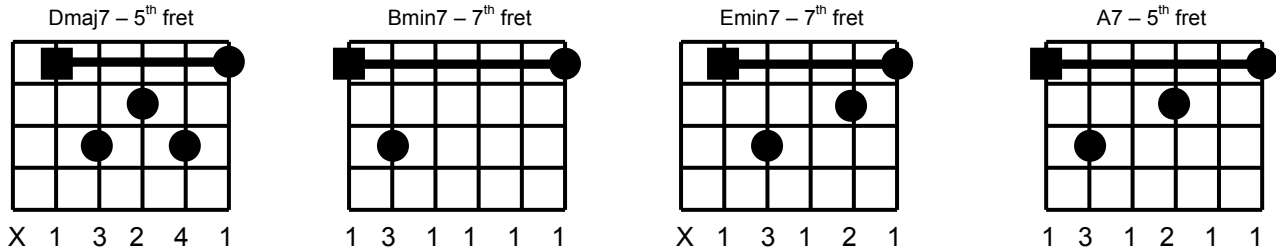

Dmaj7 – Bm7 – Em7 – A7

1. **Play what relates to all** – D major scales, (Ionian mode), over all the chords, D Major Pentatonic will also work over all
2. **Treat each chord as a separate event**
 - Over the **Dmaj7 chord** – try D Major Scales, D Lydian, and Dmajor7 arpeggios
 - Over the **Bm7 chord**– play B Aeolian, B Dorian, B Minor Pentatonic & Blues, and Bm, Bm7, and Bm9 arpeggios
 - Over the **Em7 chord** - play E Aeolian, E Dorian, E Minor Pentatonic & Blues, and Em, Em7, and Em9 arpeggios
 - Over the **A7 chord** – play A Mixolydian, A Major Pentatonic, and A Major and A7 arpeggios

m7 arpeggio – play over the Bm7 and Em7 chords

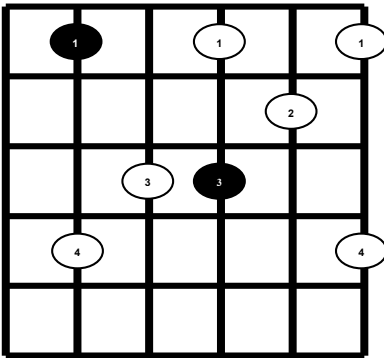

Maj7 arpeggio – play over the Dmaj7 chord

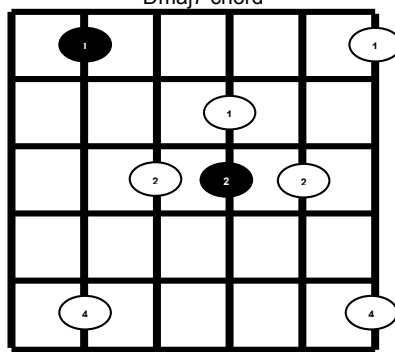

7th arpeggio – play over the A7 chord

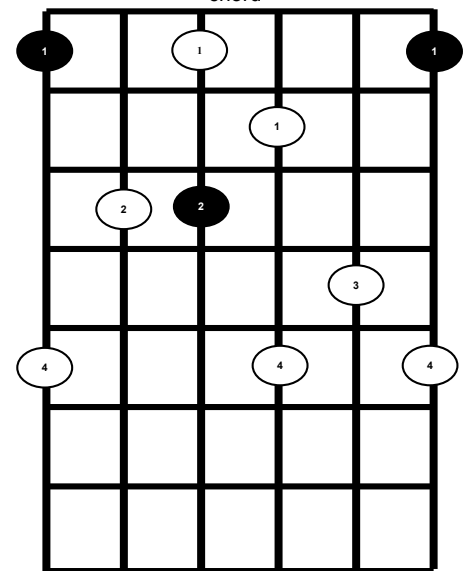

m9th arpeggio – play over the Bm7 or Em7 chords

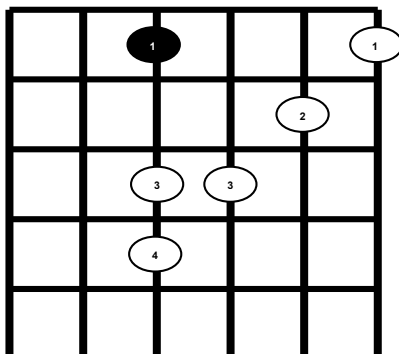

Maj7 arpeggio – play over the Dmaj7 chord

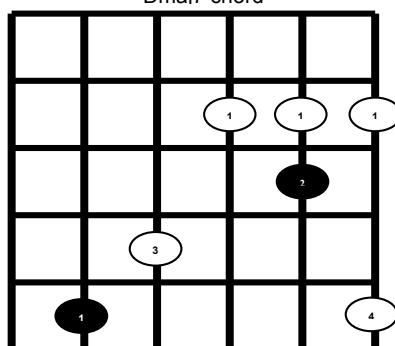

Copyright Next Level Guitar Inc., 2010
All rights reserved – unauthorized duplication or distribution is prohibited

More arpeggio playing exercises playing over each chord

In this exercise we will continue practicing playing arpeggios over chords. One goal of this exercise is to be able to phrase an arpeggio over each chord, treating each chord like a separate event. Once comfortable with the arpeggios you will be amazed at how awesome they sound played over the proper chord.

Below is a progression utilizing all of the chords in the key of B minor. As always, we need to analyze the chords, as they will give you the road map to what you can utilize when soloing. Since we are in the key of B minor we know that one choice is to utilize B Minor Pentatonic & Blues scales over all the chords as that relates to all. We are in minor key, so we must look to see if there is a IV chord and/or a II chord and if they are minor or major. Remember the rules of soloing in minor key for playing over all the chords— you can always use Aeolian mode unless the IV chord is major or the II chord is minor, then use Dorian mode. The fourth chord in this progression is minor, Em7 so Aeolian looks pretty good so far. However, at first look the two chord, (C#m7b5). It seems minor but actually the m7b5 is also known as the "half diminished" chord. A half-diminished seventh chord is a seventh chord built from the seventh degree of a major scale. It's considered "half-diminished" because a true diminished seventh has a double-flatted seventh, making it the same as a major sixth. The half-diminished seventh chord uses a minor seventh over a diminished triad. It consists of the root, minor third, flatted fifth, and a dominant seventh. The minor seven flat five chord is found at the seventh degree of the major scale, and the second degree of the minor scale. Since it's built off the seventh its more of a major family chord than minor family so we can utilize B Aeolian, (same as D major emphasizing the B notes), over all the chords. Below are the shapes and fingerings for some different arpeggios that you can blast over each chord. Watch the root notes and your timing, as you don't want to get caught playing the wrong arpeggio over the wrong chord. When you get these down cold remember good arpeggio playing mixes arpeggios in with your scales and modes, not necessarily just playing an arpeggio straight up and down. So mix them in with this progression and with B minor Pentatonic and Blues and the B Aeolian mode.

Em7 – A7 – Dmaj7 – Gmaj7 – C#m7b5 – F#7 – Bm

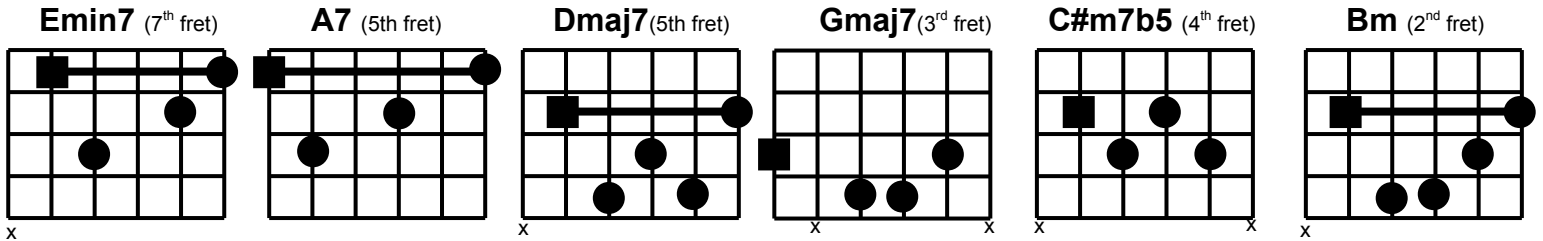

m7 arpeggio – play over the Em7 and Bm chords

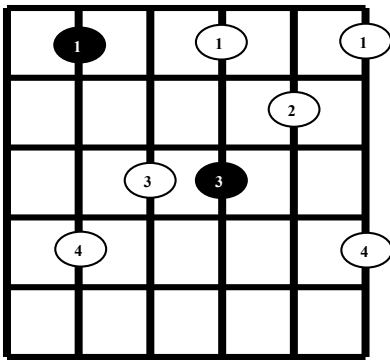

7th arpeggio – play over the A7 and F#7 chords

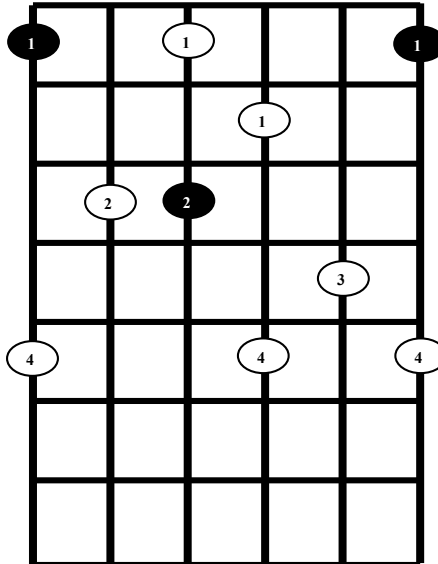

Maj7 arpeggio – play over the Dmaj7 and Gmaj7 chords

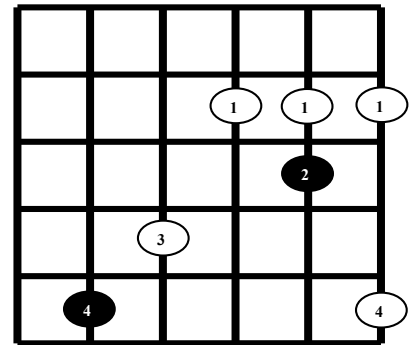

m7b5 arpeggio – play over the C#m7b5 chord

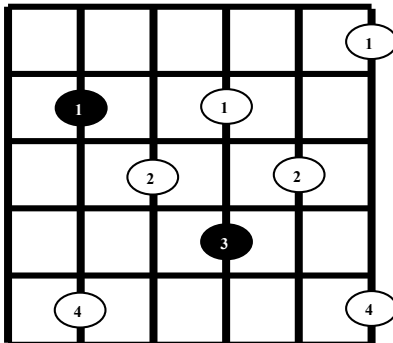

Maj7 arpeggio – play over the Dmaj7 and Gmaj7 chords

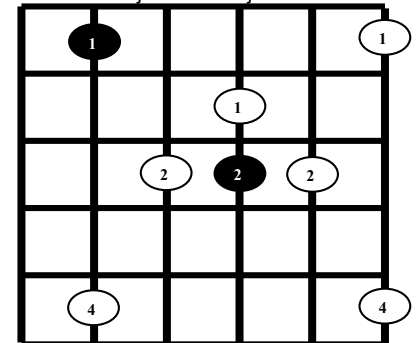

Copyright Next Level Guitar Inc., 2010 - all rights reserved – unauthorized duplication or distribution is prohibited

Sus4 and 7thSus4 Long Form Arpeggios

The two arpeggios illustrated below are Suspended fourth arpeggios. The one on the left is a G suspended 4th arpeggio, (Gsus4), and the one on the right is a G7sus4, suspended fourth arpeggio. Basically the 7sus4 is the same, but adds the b7th notes. This arpeggio really sounds best when played descending. You can also slide into the fingerings utilizing your second finger as a pivot. They sound great when played in a descending line over suspended and 7th chords respectively. Finger the black dot on the root note and practice these in all keys.

Gsus4 arpeggio

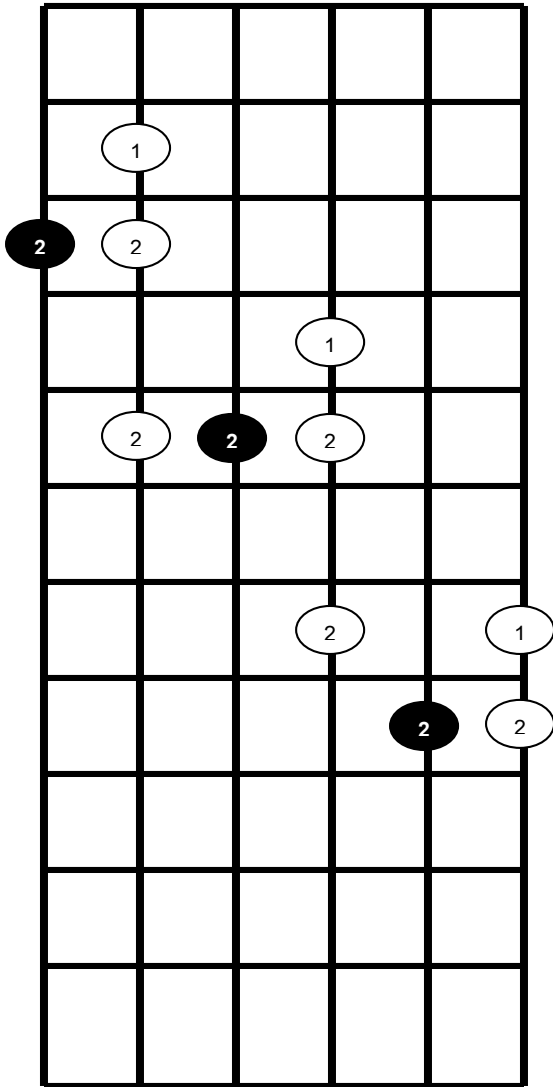

G7sus4 arpeggio

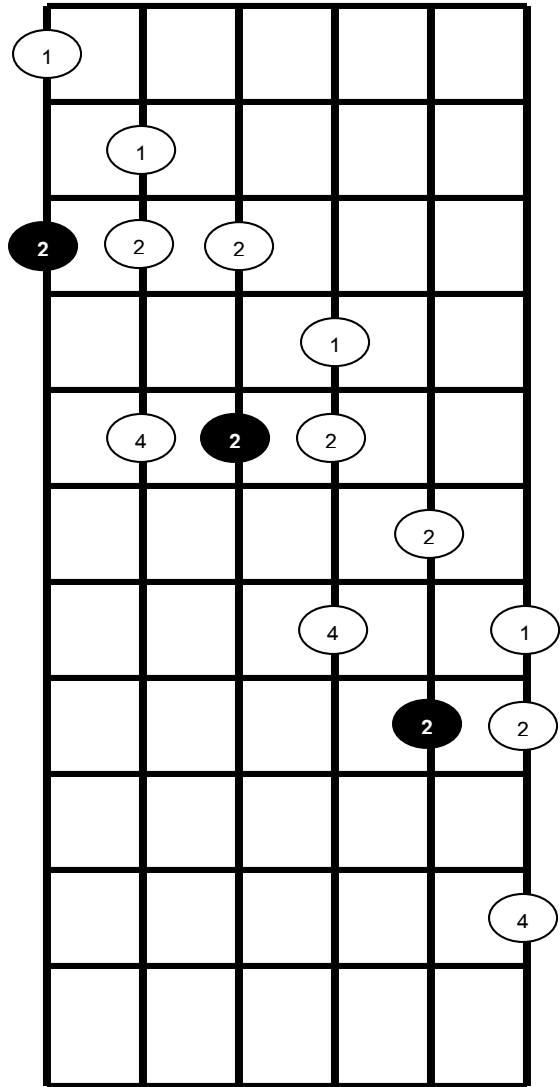

● = root note

○# Fingering to be utilized

MINOR PENTATONIC MADNESS OVER CHORDS

Let's examine how we can use the pentatonic scale in ways that can give you different and unique sounds. As discussed previously, a pentatonic scale is made from five notes, (Penta is Latin for five). We will take Minor Pentatonic first, and then look at different ways of applying the Major Pentatonic scale on the next page. The minor pentatonic scale consists of five notes from the Natural Minor scale (1, b3rd, 4th, 5th, and b7th).

1. MINOR PENTATONICS OVER MINOR TYPE CHORDS

Lets examine how we can use the Minor Pentatonic scale in other ways over minor chords then just playing the minor pent scale over the root. For example, lets take an E minor seventh chord. An Em7 chord is made from the scale degrees of root, b3rd, 5th, and b7th. So the notes in an Em7 chord would be E-G-B-D. Basically you are adding a D note or b7th to an E minor triad, E-G-B.

Em7 chord – 1, b3rd, 5 th , b7th	E-G-B-D
E minor Pentatonic – r,b3, 4, 5, b7	E-G-A-B-D
E Dorian mode – 1, 2, b3, 4, 5, 6, b7	E-F#-G-A-B-C#-D

(E Dorian adds the 2nd, F#, and 6th, C# to E minor pent scale)

At times you can utilize THREE minor pentatonic scales over a minor type chord – so for example over Em7 chord play:

- | | | |
|---|---------------------|--|
| 1. the one off the root – E minor pentatonic | E – G – A – B – D | |
| 2. go up a whole step – F# minor pentatonic | F# - A – B - C# - E | adds the 2 nd (F#) and 6 th (C#) |
| 3. go up a fifth – B minor pentatonic | B – D – E – F# - A | adds the 2 nd (F#) |

Examine the notes that you will play utilizing each minor pentatonic scale over the Em7 chord. As illustrated above all three minor pentatonics that you can utilize over the Em7 chord have all the notes in the E Dorian mode. So this technique gives you a real Dorian sound. Most guitarists would just utilize the minor pentatonic scale over the root, but this technique gives you three super useful scales to play over a minor type chord. The cool thing about using three pentatonic minor scales over a minor type chord or Dorian progression is that you can play the same licks in each shape – changing the key gives each a unique sound over the progression – so you get three different sounds. Try mixing them up and play off each one and get three different tonal variations. Try this technique over other minor chords and in different keys as per the jam track audio cd.

Remember that utilizing the three minor pentatonics off the root, 2nd, and 5th, gives you the Dorian scale. So when playing over all the chords in which the Dorian mode would work, then the three pentatonics over all the chords would work too! You can also use the three over each different minor chord in the progression.

Example: Am7- D progression – as always your first step should be to analyze the chords to get the roadmap of what to use improvisation and solo wise. The progression is in the key of A minor. Its basically a I minor to a IV major. So by examining the chords lets look at a few options that we can use for solo and improvisation. There are so many things you can do – isn't the guitar awesome!

-Try Am Pentatonic and Blues scales over both chords – remember you can use minor pentatonic and blues any time you are playing in a minor key without a major V chord – that should be your default setting.

-Try A Dorian, (=G major). We know Dorian works over both chords because you have a minor key progression where the IV chord is major, so that means A Dorian is an option when playing over all the chords.

-Try the three minor pent scales for the Dorian flavor over all chords since you know Dorian works over all:

1. off the root – use all your **A minor pentatonic scales**
2. go up a up a whole step and use all your **B minor pentatonic scales**
3. up a fifth and use all your **E minor pentatonic scales**

-use Am, Am7, Am9 arpeggios over the Am7 chord

-use D maj arpeggios over the D chord

-use A Phrygian, (=Fmajor), over the Am7 chord – produces an exotic sound characterized by the b2 (Bb note)

-use A Aeolian (=C major) over the Am7 chord

MAJOR PENTATONIC MADNESS OVER CHORDS

The Major Pentatonic scale consists of five notes pulled from the major scale, (1, 2nd, 3rd, 5th, and 6th). Much like Minor Pentatonic, as discussed in the previous page, there are three Major Pentatonic scales that can be played over Major type chords. The three scales are based off the root, fourth and fifth of the major chord (I,IV,V).

Major Pentatonics over major type chords:

So let's examine how we can use major pentatonic scales in different ways to get unique tones. For example let's look at the key of G. The I-IV-V chords in the key of G are G, C, and D. So over a Gmaj7 chord you can play all three major pentatonics – G major Pentatonic, C major Pentatonic, and D major Pentatonic. All the combined notes of these three scales gives you a Major scale sound.

- 1. one off the root** - G major pentatonic – G, A, B, D, E
- 2. the one off the 4th** - C major Pentatonic – C, D, E, G, A (adds the 4th, the C note)
- 3. the one off the 5th** - D major Pentatonic - D, E, F#, A, B (adds the 7th, the F# note)

As illustrated above, if we put all fifteen notes together from the three Major Pentatonic scales, there is really only seven notes - G, A, B, C, D, E, F# - which are the notes in G major. So you can play similar licks from the three different major pentatonic scales and get three different sounds. This is super useful when soloing and improvising. **So look for the three major pentatonic scales when improvising over major type chords – the one off the root, the one off the fourth, and the one off the fifth, (I-IV-V).**

TIP: Here is a tip if you think more along the lines of Minor Pentatonic and see the Minor Pentatonic shapes and intervals more clearly than Major Pentatonic. I do this as I think Pentatonics more in terms of Minor. Simply convert the Major Pentatonics to their relative minor pentatonics. If you tend to think more in terms of minor pentatonics this conversion will help you see the entire fretboard easier. For our example above playing off the Gmaj7 chord here are the conversions – **think minor pentatonic up a 6th, up a whole step, and up a third.**

- 1. major pentatonic off the root** converts to the **minor pentatonic scale up a 6th** – E minor pent=G maj pent
- 2. major pentatonic off the 4th** converts to the **minor pentatonic scale up a whole step** - A minor pent=Cmaj pent
- 3. major pentatonic off the 5th** converts to the **minor pentatonic scale up a third** – B minor pent=Dmaj pent

Example: Dmaj7 vamp – no chordal movement, just a vamp on a Dmaj7 chord so it's pretty wide open.

Some suggestions on lead guitar avenues:

-Try D major scales (will work but I prefer Lydian mode over major 7th chords)

-Try D major pentatonic (=B Minor Pentatonic)

-Try G major pentatonic (=E Minor Pentatonic)

-Try A major pentatonic (=F# Minor Pentatonic)

-Try D Lydian mode, (=A major) Lydian sounds great over major 7th chords as it has that cool sounding #4 note. In D Lydian the #4 is a G# note instead of the G natural in a straight D major scale. Play both and listen to the difference.

-Try E major scales – playing the major scale up a whole step over maj7 chords will give you a very outside sound as it will add a b9, (Eb note), and the Lydian #4 note, (G# note)

-Try arpeggios or triads off each I-IV-V – play the D major triad (D,F#,A), the G major triad (G,B,D), and the A major triad (A, C#, E) – all three have the notes in the D major scale. Play all three major arpeggios in different positions on the neck and get different cool tones.

-Similar to the point above you can play the major seventh arpeggios off the I-IV-V. All add the major 7th note which sounds very cool. Play D maj7 arpeggio which adds the C# note, the G maj7th arpeggio will add the F# note, and the real hip one is the A maj 7th arpeggio which will add the G# note or #4 – there is that Lydian note again – very cool indeed! Experiment and listen to all the added textures and see what sounds best to your ears.

THE CIRCLE OF FIFTHS

The circle of fifths is a great visualization and reference tool to illustrate the relationships between major and relative minor keys, chords, and sharps and flats. As per the circle illustration below, there are 12 notes corresponding to the 12 numbers on a clock. Perfect fifths separate each key – hence the name “CIRCLE OF FIFTHS”. The fifth note in a C major scale is G. The fifth note in a G major scale is D, and so on around the circle. Each time you move one step clockwise you go up a perfect fifth.

Along the outside of the circle are major keys and their corresponding RELATIVE MINOR keys are illustrated on the inside of the circle. As per the circle – C major has Am as its relative minor, G major has Em as its relative minor. This means the notes in C major - C,D,E,F,G,A,B are the same notes as in Am - A,B,C,D,E,F,G. And so on around the circle.

C major is at the 12 o'clock position and has no sharps or flats. G major is at the one o'clock position and has one sharp, F#. D major is in the 2 o'clock position and has two sharps, F# and C#. A major is in the three o'clock position and has the F#, C#, and now adds the G#. Notice the sharps and flats are added in a sequential order. This is the “order of sharps and flats” which will be discussed on the next page. Moving counterclockwise to the next neighboring key you go down a perfect fifth. Looking at each key you have the dominant chord to its right and its subdominant to its left. For example in the key of C major you have the subdominant F chord directly to the left of C, and the dominant G chord directly to the right – 1, 4, 5 or the C, F, and G chords in the key of C major. In other words, in the circle of fifths you always have the three primary chords next to one another – the tonic or root in the center, the subdominant on the left, and the dominant on the right. Moving clockwise you either add one sharp or deduct one flat as you move from key to key. Moving counter clockwise you either deduct one sharp or add one flat. This illustrates that there is only one note difference between a key and the next key a fifth away. Notice how the illustration displays only a one-note difference as you move from key to key on the circle. For example, going from C major with no sharps or flats, clockwise a fifth away to its neighbor G major, which has one sharp. The F note is raised a half step to an F# - one half step difference between the two keys. Going counterclockwise you would just flatten the B note – B to Bb. Follow this same formula around the circle.

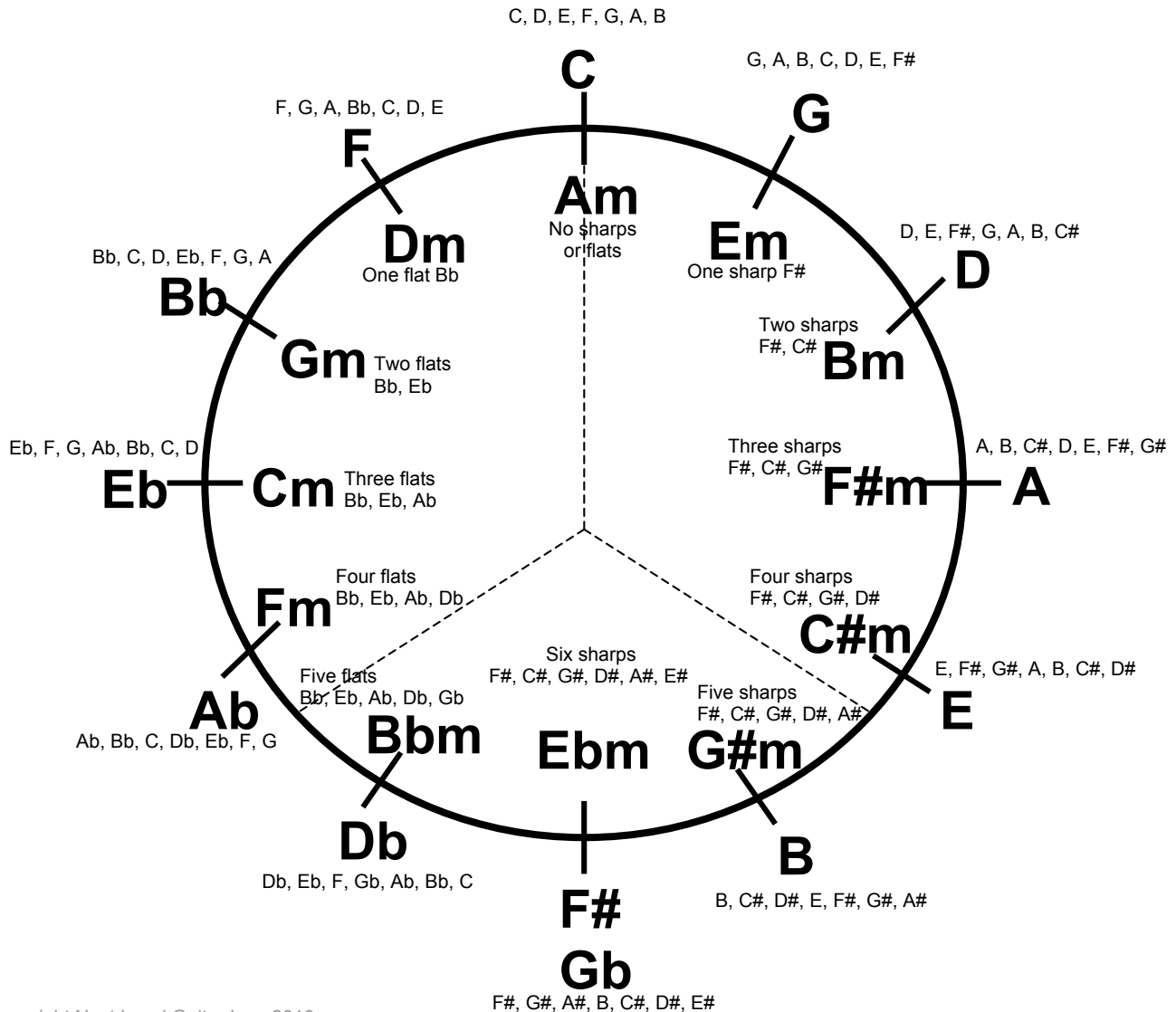

Order of sharps and flats

Let's write out the notes in the circle of fifths in order going clockwise for sharps, then counter clockwise for flats and insert them into a table. As illustrated in the two tables below you can clearly see the sequential order when we go up or down in fifths as we add sharps or flats. The sharps or flats **always appear in the same order in all key signatures**. This is the same order in which they are added, as keys get sharper or flatter.

The first table illustrated below is the table of sharps. The order of fifths is listed going down column one starting with C and going clockwise around the circle of fifths. Row one states the key of C major has zero sharps. Row two displays that G major has one sharp, F#. D major has two sharps, F#, and then add the next sharp in the order C#. And so on down the list of fifths adding sharps in order. If a key has only one sharp, then you know it must be an F#, as F# is the first sharp in the order of sharps. You also then know that the key must be G major, (E minor), as G major is the only key with one sharp. D major is the only key with two sharps. A major has three sharps, F#, C#, and the third sharp, G#, and so on. The order of sharps is: F sharp, C sharp, G sharp, D sharp, A sharp, E sharp, and B sharp as displayed in the table below.

C	0#							
G	1#	F#						
D	2#	F#	C#					
A	3#	F#	C#	G#				
E	4#	F#	C#	G#	D#			
B	5#	F#	C#	G#	D#	A#		
F#	6#	F#	C#	G#	D#	A#	E#	
C#	7#	F#	C#	G#	D#	A#	E#	B#

Order of sharps
F#, C#, G#, D#, A#, E#, B#

The next table below illustrates the order of flats. Like the table above the order of fifths is listed going down column one starting with C and going counterclockwise around the circle of fifths. The order of flats is the reverse order of sharps: Bb, Eb, Ab, Db, Gb, Cb, Fb. So the key with only one flat, F major, (D minor) has a B flat; the keys with two flats, B flat major (G minor) have the B flat and next note in the order, E flat; and so on. F is the only major key with one flat, Bb – and so on down the table.

C	0b							
F	1b	Bb						
Bb	2b	Bb	Eb					
Eb	3b	Bb	Eb	Ab				
Ab	4b	Bb	Eb	Ab	Db			
Db	5b	Bb	Eb	Ab	Db	Gb		
Gb	6b	Bb	Eb	Ab	Db	Gb	Cb	
Cb	7b	Bb	Eb	Ab	Db	Gb	Cb	Fb

Order of flats
Bb, Eb, Ab, Db, Gb, Cb, Fb

To remember the order:
Fast Cars Get Driven
Around Every Boulevard

Order of sharps →
F, C, G, D, A, E, B
← **Order of flats**

These tables are very useful when determining how many, and which sharps or flats are in a given key. If you know the order of sharps and flats and know your circle of fifths, then you don't even need to look at your instrument to figure out all the notes in any given major key or relative minor key. For example, E major is at the four o'clock position on the circle of fifths. Therefore it has 4 sharps. Knowing the order of sharps they must be F#, C#, G#, and D#. Fill in the rest of the notes starting from the E and you have E, F#, G#, A, B, C#, and D# - all the notes in an E major scale. Apply these formulas to all keys.

Blank tablature staffs to write out your favorite licks

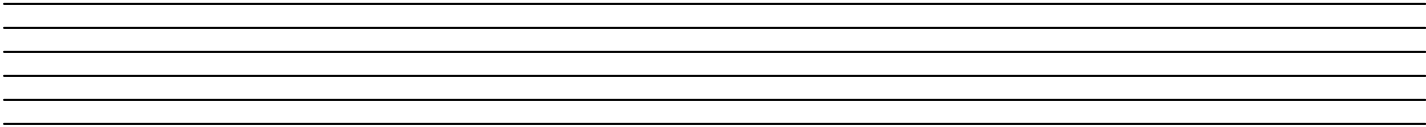
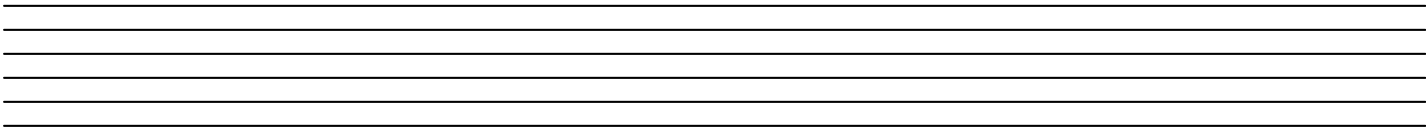
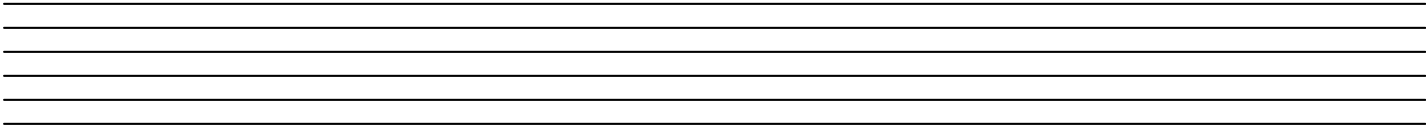
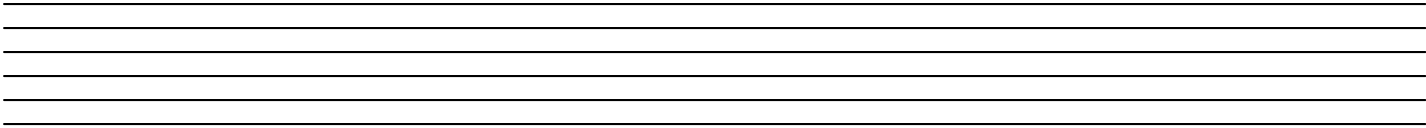
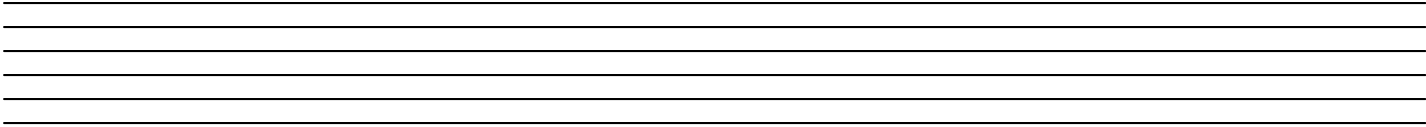
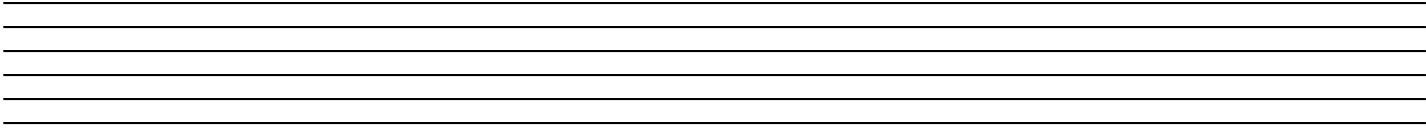

Blank tablature staffs to write out your favorite licks

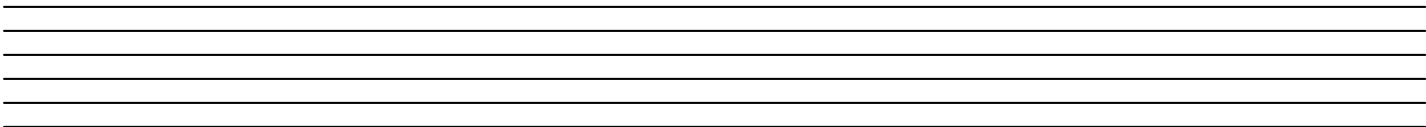
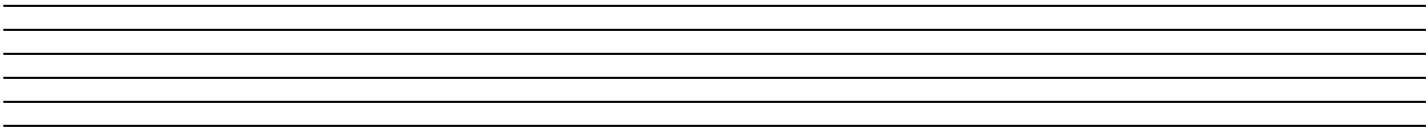
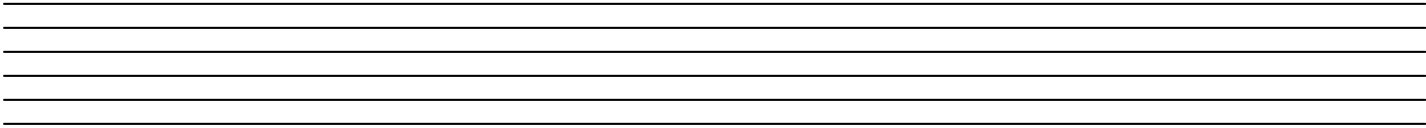
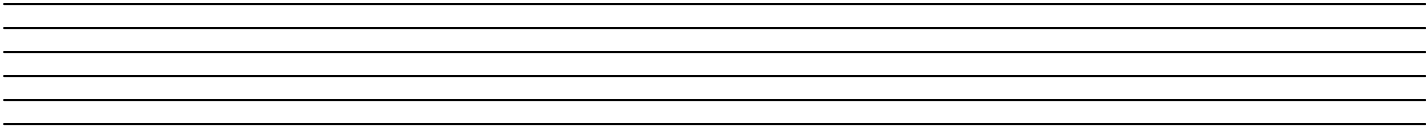
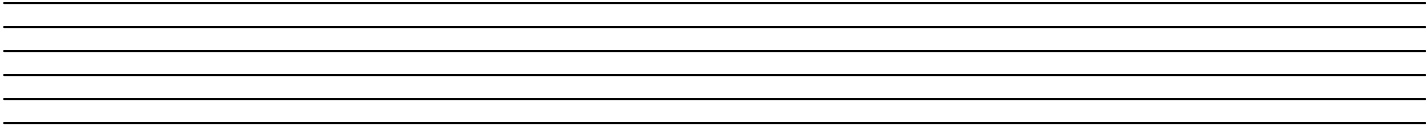

Blank tablature staffs to write out your favorite licks

